

RELIANCE INSTRUMENTS
CORPORATION

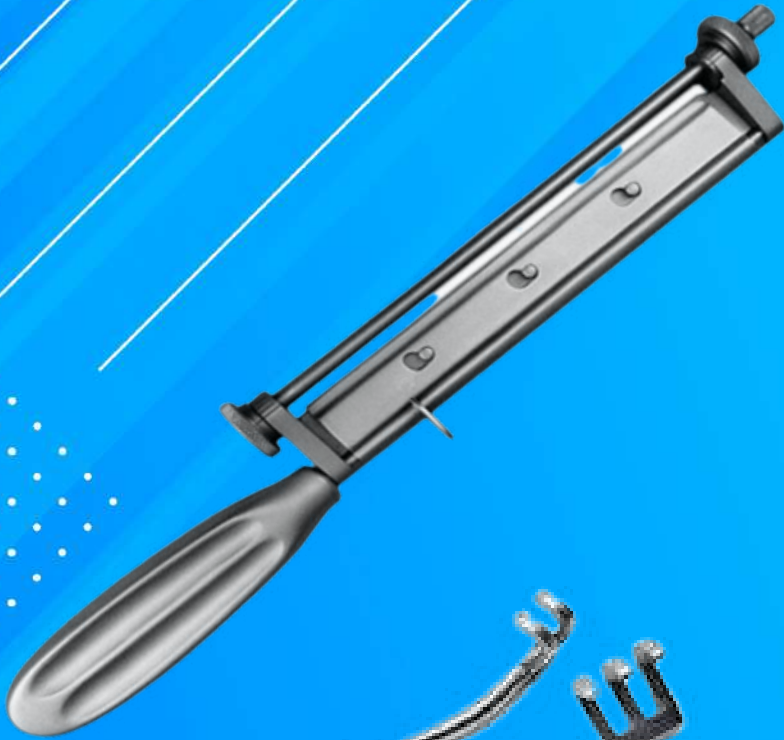
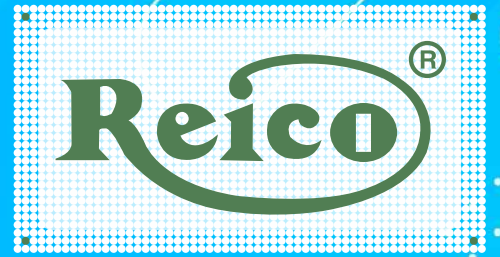

**SURGICAL
INSTRUMENTS
CATALOGUE**
JUNE - 2023 EDITION

TABLE OF CONTENTS

S.No		Page No
1	SUCTION TUBES	3 - 4
2	SCALPEL HANDLES	5
3	OPERATING SCISSORS & DISSECTING SCISSOR	6 - 9
4	GYNECOLOGICAL, IRIS & TENDON SCISSORS	10
5	GUM, STITCH & WIRE CUTTING SCISSORS	11
6	SUPER CUT SCISSORS	12
7	PLASTER SCISSORS	13 - 14
8	PLASTER SHEARS	15
9	OPERATING SCISSORS T/C INSERTED	16
10	OPERATING & DISSECTING SCISSORS T/C INSERT	17
11	VASCULAR, DISSECTING & PLASTER SCISSORS T/C INSERT	18
12	DRESSING & TISSUE FORCEPS	19 - 22
13	TISSUE & DRESSING FORCEPS T.C	23
14	HAEMOSTATIC FORCEPS	24 - 27
15	TOWEL FORCEPS	28 - 29
16	SPONGE FORCEPS	30
17	NEEDLE HOLDERS	31 - 33
18	NEEDLE HOLDERS T.C	34 - 39
19	HOOKLETS, RETRACTORS	40 - 45
20	PERIOSTEAL ELEVATORS	46
21	DURA HOOKS/ NERVE HOOKS	47
22	LAMINECTOMY RONGEURS	48 - 49
23	KERRISON PUNCHES	50
24	DISC PUNCH OR DISC RONGEUR	51 - 56
25	SKIN GRAFTING HANDLES	57

SUCTION TUBES



POOL
RIC-01-570 30 Fg.



POOL
RIC-01-575 30 Fg.



COOLEY
RIC-01-580
33.0 cm, 13"



COOLEY
RIC-01-585
35 cm, 13 3/4"



COOLEY
RIC-01-590
30.0 cm, 12"



COOLEY
RIC-01-595
31.0 cm, 12 1/4"



MILLIN'S SUCTION TUBE
RIC-01-600
chromium-plated,
with sliding "on & off"
action.

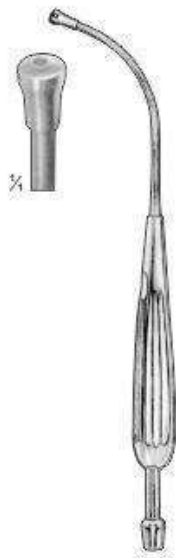

YANKAUER
RIC-01-605



YANKAUER
RIC-01-610
28.5 cm, 11"
with especially large
central bore, 4.8 mm
diam



YANKAUER
RIC-01-615
28.5 cm, 11"
with central bore,
2.0 mm Diam.



DE-BAKEY
RIC-01-620
28.5 cm, 11"
with central bore,
3.0 mm Diam. With
lateral slots

SUCTION TUBES

Ø 1.5 mm



COUPLAND
RIC- 01-630

Ø 2.0 mm



BYRD
RIC- 01-640 1.5 mm
RIC- 01-645 2.5 mm
RIC- 01-650 3.5 mm

Ø 5 mm



DE-BAKEY
RIC- 01-660
16 cm, 5"
with finger cut-off
and stylet

Ø 4 mm



RIC- 01-665
19 cm, 7 1/4"
cut-off

Ø 5 mm



DE-BAKEY
RIC- 01-670
27 cm, 10 3/4"
with finger cut-off
and stylet



RIC- 01-680 Ø 4.5 mm
RIC- 01-690 Ø 5.5 mm
17.5 cm, 7"
Nasal suction tubes



LOPEZ-REINKE
RIC- 01-700
23.5 cm, 9"
tonsil dissector with
suction device



FERGUSON
RIC- 01-710 Ø 4.0 mm
18 cm, 7"
insulated, with finger
cut-off and stylet, thumb
piece 90° to curved, with
Luer hub



FRAZIER
RIC- 01-720 Ø 3.0 mm
RIC- 01-725 Ø 5.0 mm
18 cm, 7"
insulated, with finger
cut-off and stylet, thumb
piece 90° to curved, with
Luer hub



RIC- 01-730
18 cm, 7"
Ø 5.0 mm diam., Tip
6.5 mm wide nasal
section tube, with
luer hub

SCALPEL HANDLES



Fig. 10 Fig. 11 Fig. 12 Fig. 15
Blade Sizes



Fig. 20 Fig. 22

#3 SCALPEL HANDLE
RIC-02-100
12.75 cm, 5"
Blade Size
10, 11, 12, 15

#3 SCALPEL HANDLE/ GRADUATED
RIC-02-110
12.75 cm, 5"
Blade Size
10, 11, 12, 15

#4 SCALPEL HANDLE
RIC-02-120
12.75 cm, 5"
Blade Size
20, 22, 25

4L SCALPEL HANDLE
RIC-02-130
21 cm, 8 1/4"

SCALPEL PLASTIC HANDLE
RIC-02-140
8

COLLIN
RIC-02-150
9



SCALPEL PLASTIC HANDLE
RIC-02-160
5

SCALPEL PLASTIC HANDLE
RIC-02-170
6

#3, #4 SCALPEL HANDLE
RIC-02-180
16 cm, 6"

SCALPEL HANDLE 3L LONG
RIC-02-190
21 cm, 8 1/4"
Blade Size 10, 11, 12, 15

#7 SCALPEL HANDLE
RIC-02-200
16.5 cm, 6 1/2"
Blade 10, 11, 12, 15

SCALPEL HANDLE 4L long
RIC-02-210
21 cm, 8 1/4"

#3 SCALPEL HANDLE / LONG ANGLED
RIC-02-220
20.25 cm, 8 1/4"
Blade Size 10, 11, 12, 15

OPERATING SCISSORS

ROUND PATTERN



STANDARD STRAIGHT

RIC- 03-100	11.5 cm, 4 1/2"
RIC- 03-101	13.0 cm, 5"
RIC- 03-102	14.0 cm, 5 1/2"
RIC- 03-103	15.0 cm, 6"
RIC- 03-104	16.0 cm, 6 1/4"
RIC- 03-105	17.5 cm, 7"
RIC- 03-106	18.5 cm, 7 1/4"
RIC- 03-107	20.0 cm, 8"
S/S Str.	

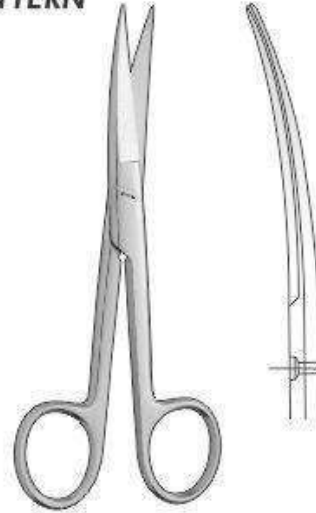

STANDARD CURVED

RIC- 03-120	11.5 cm, 4 1/2"
RIC- 03-121	13.0 cm, 5"
RIC- 03-122	14.0 cm, 5 1/2"
RIC- 03-123	15.0 cm, 6"
RIC- 03-124	16.0 cm, 6 1/4"
RIC- 03-124	17.5 cm, 7"
RIC- 03-125	18.5 cm, 7 1/4"
RIC- 03-126	20.0 cm, 8"
S/S Cvd.	

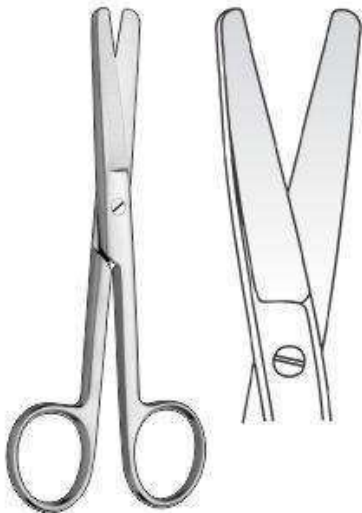

STANDARD STRAIGHT

RIC- 03-140	11.5 cm, 4 1/2"
RIC- 03-141	13.0 cm, 5"
RIC- 03-142	14.0 cm, 5 1/2"
RIC- 03-143	15.0 cm, 6"
RIC- 03-144	16.0 cm, 6 1/4"
RIC- 03-145	17.5 cm, 7"
RIC- 03-146	18.5 cm, 7 1/4"
RIC- 03-147	20.0 cm, 8"
B/B Str.	

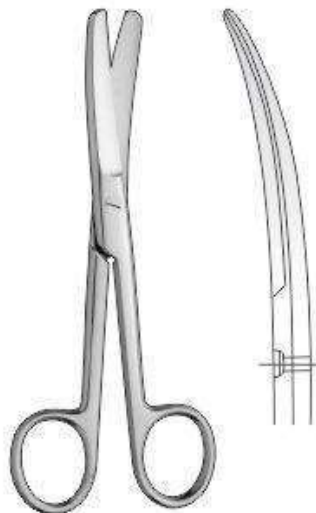

STANDARD CURVED

RIC- 03-160	11.5 cm, 4 1/2"
RIC- 03-161	13.0 cm, 5"
RIC- 03-162	14.0 cm, 5 1/2"
RIC- 03-163	15.0 cm, 6"
RIC- 03-164	16.0 cm, 6 1/4"
RIC- 03-165	17.5 cm, 7"
RIC- 03-166	18.5 cm, 7 1/4"
RIC- 03-167	20.0 cm, 8"
B/B Cvd.	



STANDARD STRAIGHT

RIC- 03-180	11.5 cm, 4 1/2"
RIC- 03-181	13.0 cm, 5"
RIC- 03-182	14.0 cm, 5 1/2"
RIC- 03-183	15.0 cm, 6"
RIC- 03-184	16.0 cm, 6 1/4"
RIC- 03-185	17.5 cm, 7"
RIC- 03-186	18.5 cm, 7 1/4"
RIC- 03-187	20.0 cm, 8"

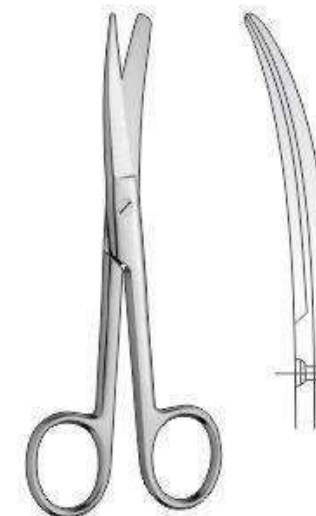

STANDARD CURVED

RIC- 03-200	11.5 cm, 4 1/2"
RIC- 03-201	13.0 cm, 5"
RIC- 03-202	14.0 cm, 5 1/2"
RIC- 03-203	15.0 cm, 6"
RIC- 03-204	16.0 cm, 6 1/4"
RIC- 03-205	17.5 cm, 7"
RIC- 03-206	18.5 cm, 7 1/4"
RIC- 03-207	20.0 cm, 8"

OPERATING, DISSECTING SCISSORS



DEAVER
RIC-03-220
14.0 cm, 5 ½"

DEAVER
RIC-03-230
14.0 cm, 5 ½"

MIXTER
RIC-03-240
15.5 cm, 6"

MIXTER
RIC-03-250
15.5 cm, 6"

JORGENSEN
RIC-03-260
22 cm, 8 ½"
Curved



INCISION SCISSORS
RIC-03-270 13.0 cm, 5"
RIC-03-271 14.5 cm, 5 ½"



INCISION SCISSORS
RIC-03-280
15.5 cm, 6"

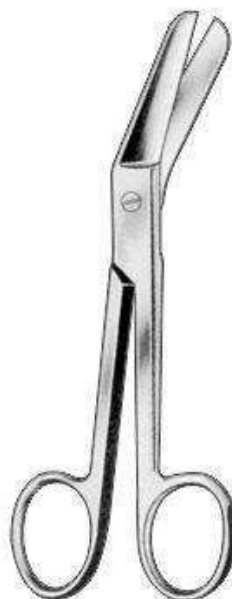

RICHTER
RIC-03-290
14.5 cm, 5 ½"



FERGUSSON
RIC-03-300 14.0 cm, 5 ½"
RIC-03-311 16.5 cm, 6 ½"
RIC-03-312 18.0 cm, 7"

OPERATING & DISSECTING SCISSORS

Model	Blade Length	Blade Type
RIC-03-323	14.5 cm, 5 1/2"	Str.
RIC-03-324	15.0 cm, 6"	Str.
RIC-03-325	17.0 cm, 6 3/4"	Str.
RIC-03-342	15.0 cm, 6"	Cvd.
RIC-03-343	17.0 cm, 6 3/4"	Cvd.
RIC-03-351	17.0 cm, 6 3/4"	Cvd.
RIC-03-360	14.5 cm, 5 3/4"	Str. & Cvd.
RIC-03-361	18.0 cm, 7"	Str. & Cvd.
RIC-03-362	20.0 cm, 8"	Str. & Cvd.
RIC-03-363	23.0 cm, 9"	Str. & Cvd.
RIC-03-364	25.0 cm, 10"	Str. & Cvd.
RIC-03-365	28.0 cm, 11"	Str. & Cvd.
RIC-03-380	14.5 cm, 5 3/4"	Str. & Cvd.
RIC-03-381	18.0 cm, 7"	Str. & Cvd.
RIC-03-382	20.0 cm, 8"	Str. & Cvd.
RIC-03-383	23.0 cm, 9"	Str. & Cvd.
RIC-03-384	25.0 cm, 10"	Str. & Cvd.
RIC-03-385	28.0 cm, 11"	Str. & Cvd.

Model	Blade Length	Blade Type
RIC-03-400	20.3 cm, 8"	Curved
RIC-03-401	22.9 cm, 9"	Curved
RIC-03-402	28.4 cm, 11"	Curved
RIC-03-410	15.25 cm, 6"	Str.
RIC-03-420	11.5 cm, 4 1/2"	Str.
RIC-03-421	11.5 cm, 4 1/2"	Cvd.
RIC-03-430	19.0 cm, 7 1/2"	Str.

FACE-LIFE, DISSECTING, NASAL SCISSORS & OPERATING

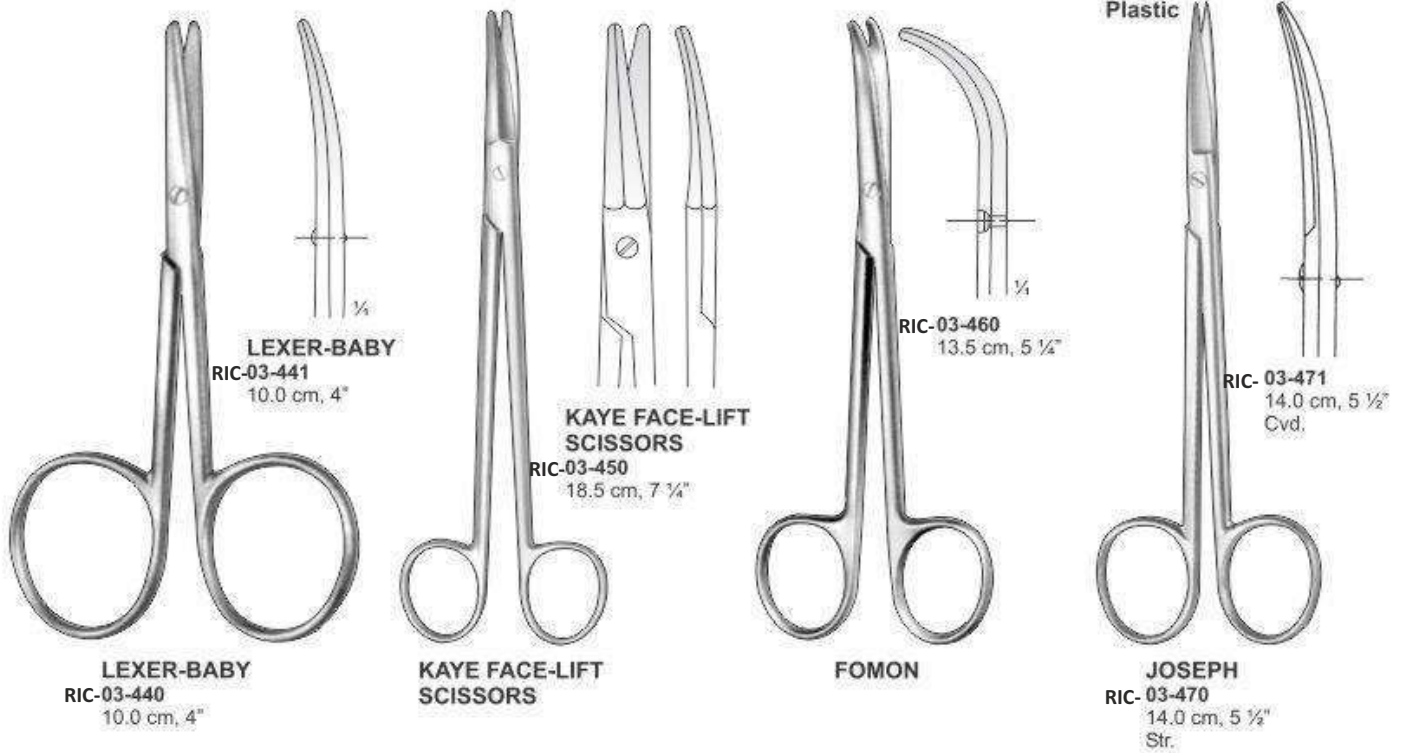

RIC-



GYNECOLOGICAL, IRIS & TENDON SCISSORS

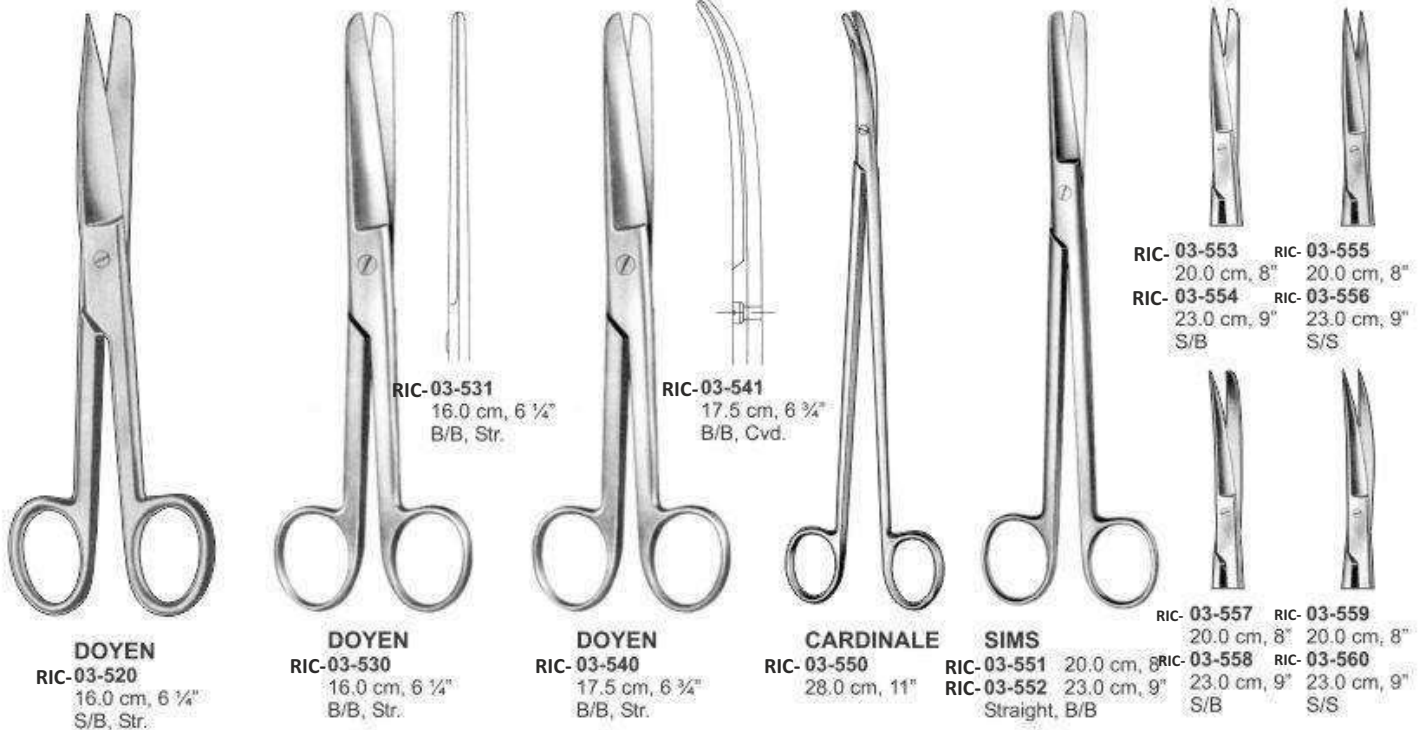

GUM, STITCH & WIRE CUTTING SCISSORS



ROUND CUT
RIC-03-860
23.5 cm, 9"



LE GRANGE
RIC-03-870
11 cm, 4 1/4"



SCHOEMAKER-LOTH
RIC-03-880
12.5 cm, 5"



SPENCER / DELICATE
RIC-03-890
11 cm, 4 1/2"



LITTAUER
RIC-03-900
14 cm, 5 1/2"



MODIFIED-USA
RIC-03-910
10 cm, 4"



BEEBEE
10.5 cm, 4"
Straight

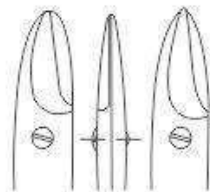

Blunt
RIC-03-920 Pointed
RIC-03-921

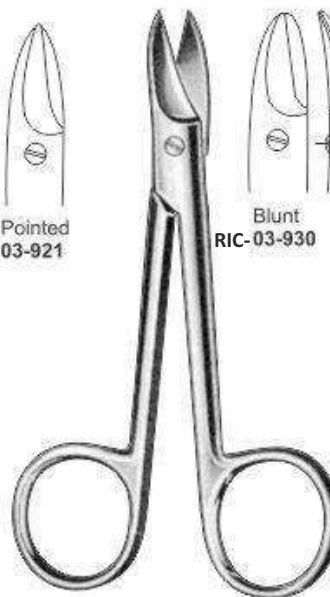

BEEBEE
10.5 cm, 4"
Curved

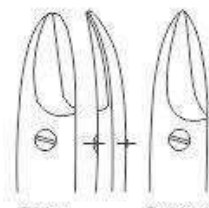

Blunt
RIC-03-930 Pointed
RIC-03-931

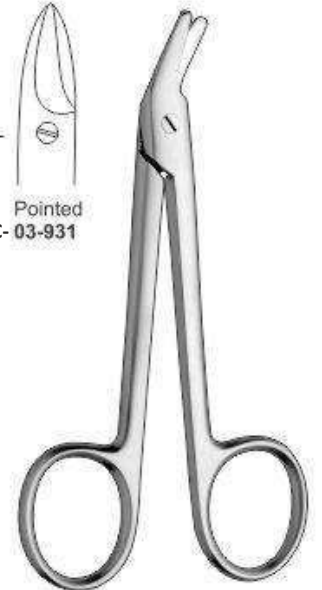

UNIVERSAL
RIC-03-940
11.5 cm, 4 1/2"

SUPER CUT SCISSORS



STANDARD
RIC-03-1020 14 cm, 5 1/2"
 Straight



STANDARD
RIC-03-1030 14 cm, 5 1/2"
 Curved



MAYO
RIC-03-1040 14 cm, 5 1/2"
RIC-03-1041 15 cm, 6"
RIC-03-1042 18 cm, 7"
RIC-03-1043 20 cm, 8"
RIC-03-1044 23 cm, 9"



MAYO
RIC-03-1050 23 cm, 9"
 Curved



MAYO
RIC-03-1060 23 cm, 9"
 Straight



GOLDMAN-FOX
RIC-03-1070 Straight
RIC-03-1071 Curved
 9.0 cm, 3 1/2"



STEVENS TENOTOMY
RIC-03-1080 Straight
RIC-03-1081 Curved
 9.0 cm, 3 1/2"



IRIS
RIC-03-1090 9.0 cm, 3 1/2"
RIC-03-1091 11.4 cm, 4 1/2"
 Straight



IRIS
Angular
RIC-03-1100 11.4 cm, 4 1/2"

PLASTER SCISSORS



UNIVERSAL (Colour Available)
RIC-03-1110 14.5 cm, 5 ¾"
 143 C/290 F Autoclavable
RIC-03-1111 15 cm, 6"
 143 C/290 F Autoclavable
RIC-03-1112 16 cm, 6 ¼"
 143 C/290 F Autoclavable
RIC-03-1113 18 cm, 7"
 143 C/290 F Autoclavable



UNIVERSAL BANDAGE
RIC-03-1120
 12 cm, 5"



BRUNS
RIC-03-1131
 24 cm, 9 ½"
 serrated



LISTER
RIC-03-1140
 Exentric
 19 cm, 7 ½"



BERGMANN
RIC-03-1150
 23 cm, 9"

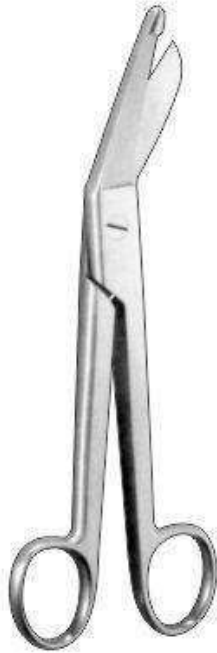

ESMARCH
RIC-03-1160
 20 cm, 8"
RIC-03-1161
 22 cm, 8 ¾"



BRAUN-STADLER
RIC-03-1170
 14 cm, 5 ½"



BRAUN-STADLER
RIC-03-1180
 20 cm, 8"

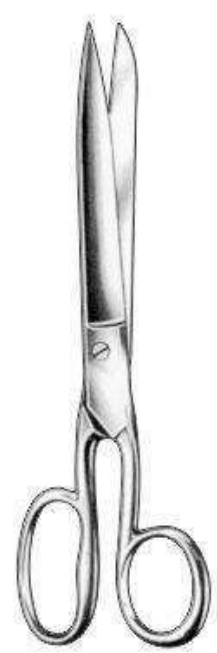

SMITH (MOD. USA)
RIC-03-1190 16 cm, 6 ¼"
RIC-03-1191 18 cm, 7"
RIC-03-1192 20 cm, 8"
RIC-03-1193 23 cm, 9"

PLASTER SCISSORS

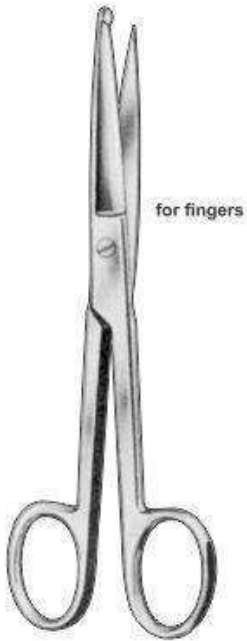

KNOWLES
RIC-03-1200
14 cm, 5 1/2"



LISTER
RIC-03-1210
21.0 cm, 8 1/4"

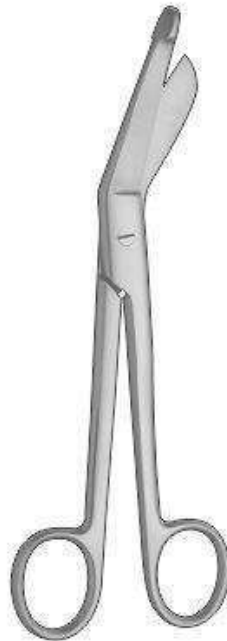

LISTER BANDAGE
RIC-03-1220 14 cm, 5 1/2"
RIC-03-1221 16 cm, 6 1/4"
RIC-03-1222 18 cm, 7"
RIC-03-1223 20 cm, 8"



LORENZ
RIC-03-1230
23 cm, 9"



KNOWLES
RIC-03-1240
14 cm, 5 1/2"



LISTER-EXCENTRIC
RIC-03-1250 16 cm, 6 1/4"
RIC-03-1251 19 cm, 7 1/2"



KNOWLES
RIC-03-1260
14cm



ESMARCH
RIC-03-1270
20cm



SEUTIN
RIC-03-1280
23cm



WIRE & CLOTHING
RIC-03-1290
20cm

PLASTER SHEARS



SHEAR

STILLE
 RIC- 03-1300 23cm
 RIC- 03-1301 26cm
 RIC- 03-1302 37cm



SAW

ENGEL
 RIC- 03-1310



KNIFE

REINER
 RIC- 03-1320
 18cm



RING CUTTER

FINGER
 RIC- 03-1330
 16cm



CAST BREAKER

WOLFF
 RIC- 03-1340 19cm
 RIC- 03-1341 23cm
 RIC- 03-1342 26cm



SPREADER

HENING
 RIC- 03-1350
 28cm

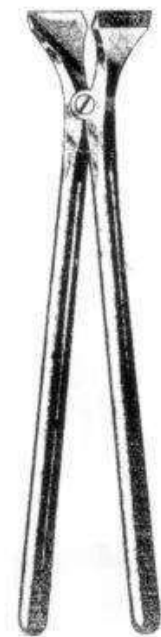

BEESON
 RIC- 03-1360
 30cm

OPERATING SCISSORS T/C INSERTED



STANDARD

03-1370 14.5 cm, 5 3/4" Straight
 03-1371 14.5 cm, 5 3/4" Curved
 03-1372 16.5 cm, 6 1/2" Straight
 03-1373 16.5 cm, 6 1/2" Curved
 03-1374 18.5 cm, 7 1/4" Straight
 03-1375 18.5 cm, 7 1/4" Curved



STANDARD

RIC-03-1390 14.5 cm, 5 3/4" Straight
 RIC-03-1391 14.5 cm, 5 3/4" Curved
 RIC-03-1392 16.5 cm, 6 1/2" Straight
 RIC-03-1393 16.5 cm, 6 1/2" Curved
 RIC-03-1394 18.5 cm, 7 1/4" Straight
 RIC-03-1395 18.5 cm, 7 1/4" Curved

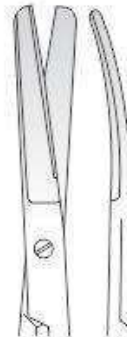

MAYO

RIC-03-1400 14 cm, 5 1/2"
 RIC-03-1401 17 cm, 6 3/4"
 RIC-03-1402 23 cm, 9"
 blunt/blunt

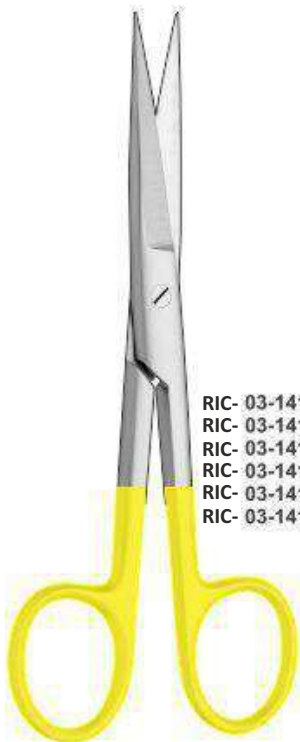
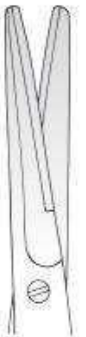

STANDARD

RIC-03-1410 14.5 cm, 5 3/4" Straight
 RIC-03-1411 14.5 cm, 5 3/4" Curved
 RIC-03-1412 16.5 cm, 6 1/2" Straight
 RIC-03-1413 16.5 cm, 6 1/2" Curved
 RIC-03-1414 18.5 cm, 7 1/4" Straight
 RIC-03-1415 18.5 cm, 7 1/4" Curved

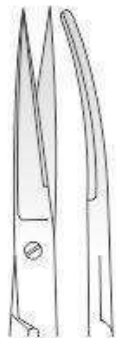

MAYO-STILLE

RIC-03-1430 15 cm, 6"
 RIC-03-1431 17 cm, 6 3/4"
 blunt/blunt, Str.

RIC-03-1432 15 cm, 6"
 RIC-03-1433 17 cm, 6 3/4"
 blunt/blunt, Cvd.



LEXER

RIC-03-1440 16 cm, 6 1/4"
 RIC-03-1441 21.5 cm, 8 1/2"
 blunt/blunt, Str.

RIC-03-1442 16 cm, 6 1/4"
 RIC-03-1443 21.5 cm, 8 1/2"
 blunt/blunt, Cvd.



OPERATING & DISSECTING SCISSORS T/C INSERT

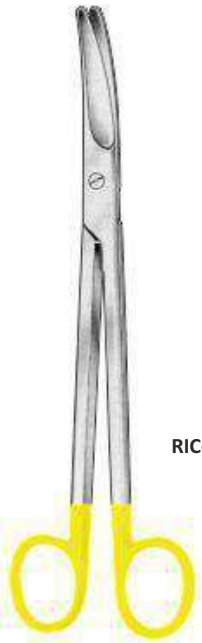

RIC-03-1450
blunt/blunt
Str.

PARAMETRIUM
23 cm, 9"

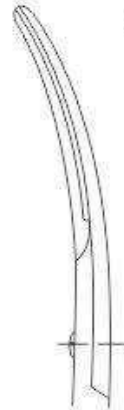

RIC-03-1451
blunt/blunt
Cvd.

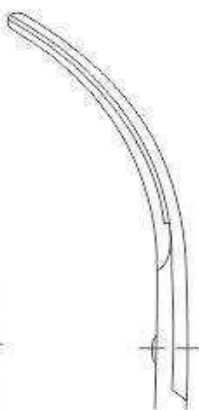

RIC-03-1452
blunt/blunt
Full Cvd.



GOLDMAN-FOX
RIC-03-1460
13.0 cm, 5"

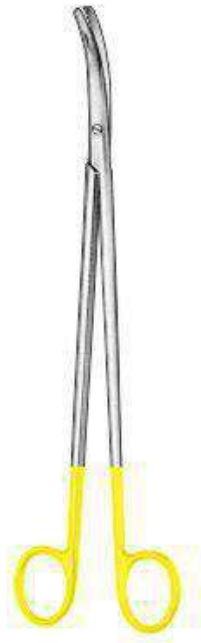

CARDINALE
RIC-03-1470
28.0 cm, 11"



SIMS
RIC-03-1480
23.0 cm, 9"
Curved



**METZENBAUM
DELICATE**

RIC-03-1490 14.5 cm, 5 3/4"
RIC-03-1491 18.0 cm, 7"
RIC-03-1492 20.0 cm, 8"
RIC-03-1493 23.0 cm, 9"
RIC-03-1494 25.0 cm, 10"
RIC-03-1495 28.0 cm, 11"
Blunt / Blunt Curved

RIC-03-1496 14.5 cm, 5 3/4"
RIC-03-1497 18.0 cm, 7"
RIC-03-1498 20.0 cm, 8"
RIC-03-1499 23.0 cm, 9"
RIC-03-1500 25.0 cm, 10"
RIC-03-1501 28.0 cm, 11"
Blunt / Blunt Straight



**METZENBAUM
DELICATE**

RIC-03-1510 14.5 cm, 5 3/4"
RIC-03-1511 18.0 cm, 7"
RIC-03-1512 20.0 cm, 8"
RIC-03-1513 23.0 cm, 9"
RIC-03-1514 25.0 cm, 10"
RIC-03-1515 28.0 cm, 11"
Sharp / Sharp Curved

RIC-03-1516 14.5 cm, 5 3/4"
RIC-03-1517 18.0 cm, 7"
RIC-03-1518 20.0 cm, 8"
RIC-03-1519 23.0 cm, 9"
RIC-03-1520 25.0 cm, 10"
RIC-03-1521 28.0 cm, 11"
Sharp / Sharp Straight



VASCULAR, DISSECTING & PLASTER SCISSORS T/C INSERTED

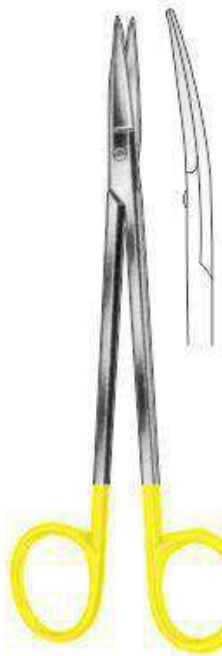

KELLY
 RIC-03-1530 Straight
 RIC-03-1531 Curved
 16 cm, 6 1/4"



GUM SCISSORS
 Locklin
 RIC-03-1540
 16 cm, 6 1/4"

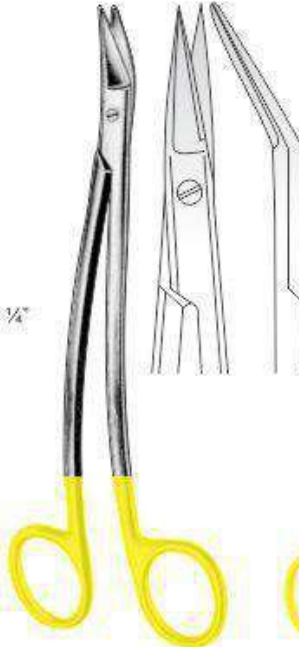

DEAN
 RIC-03-1550
 17.5 cm, 6 3/4"



DEBAKEY

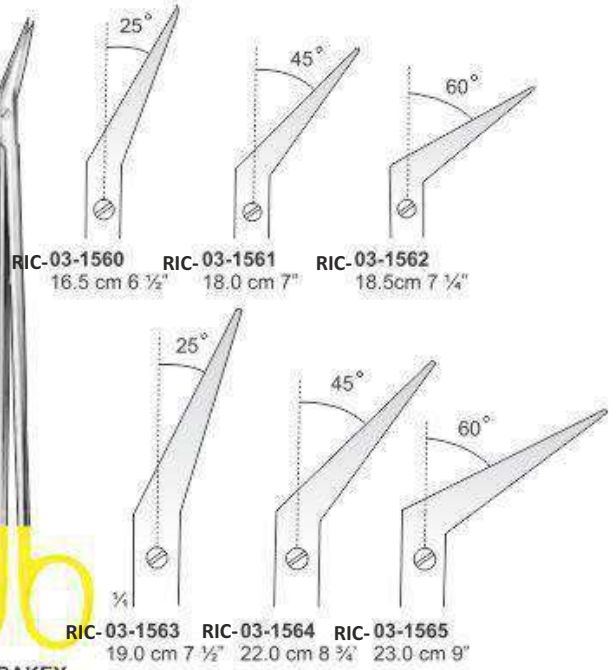

IRIS
 RIC-03-1570
 11cm 4 1/2"



IRIS
 RIC-03-1580
 11.5cm 4 1/2"

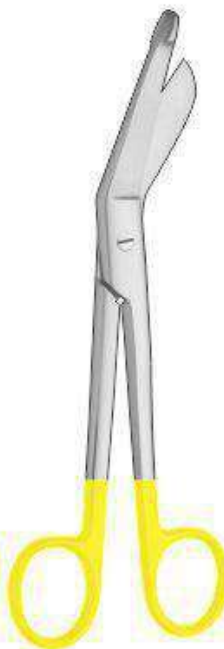

LISTER BANDAGE
 RIC-03-1590 14 cm, 5 1/2"
 RIC-03-1591 16 cm, 6 1/4"
 RIC-03-1592 18 cm, 7"
 RIC-03-1593 20 cm, 8"



BRUNS SCISSORS
 RIC-03-1600
 21 cm, 8 1/4"
 For heavy duty use
 Longlife cutting edge

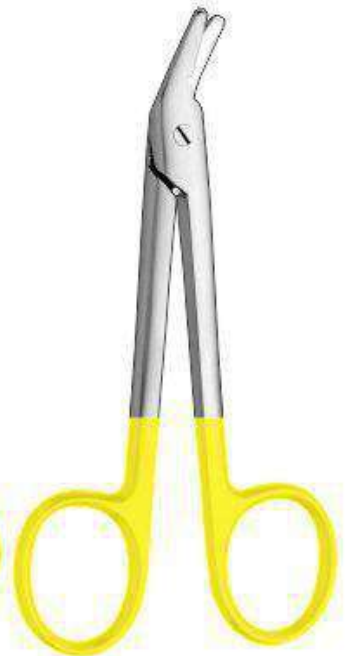

WIRE CUTTING
 RIC-03-1610
 11.5 cm, 4 1/2"

DRESSING & TISSUE FORCEPS

<p>RIC-04-100 10.5 cm, 4" RIC-04-101 11.5 cm, 4 1/2" RIC-04-102 12.5 cm, 5" RIC-04-103 14.0 cm, 5 1/2" RIC-04-104 16.0 cm, 6 1/4" RIC-04-105 18.0 cm, 7" RIC-04-106 20.0 cm, 8" RIC-04-107 25.0 cm, 10" RIC-04-108 30.0 cm, 12"</p>		<p>RIC-04-110 10.5 cm, 4" RIC-04-111 11.5 cm, 4 1/2" RIC-04-112 12.5 cm, 5" RIC-04-113 14.0 cm, 5 1/2" RIC-04-114 16.0 cm, 6 1/4" RIC-04-115 18.0 cm, 7" RIC-04-116 20.0 cm, 8" RIC-04-117 25.0 cm, 10" RIC-04-118 30.0 cm, 12"</p>		<p>RIC-04-132 12.5 cm, 5" RIC-04-133 15.0 cm, 6"</p>		<p>RIC-04-141 20 cm, 8"</p>		<p>RIC-04-151 20 cm, 8"</p>					
STANDARD		STANDARD 1:2		SEMKEN	SEMKEN 1:2	BROPHY	BROPHY 1:2						
				<p>RIC-04-120 12.5 cm, 5" RIC-04-121 15.5 cm, 6"</p>	<p>RIC-04-130 12.5 cm, 5" RIC-04-131 15.0 cm, 6"</p>	<p>RIC-04-140 20 cm, 8"</p>	<p>RIC-04-150 20 cm, 8"</p>						
<p>RIC-04-163 18 cm, 7" RIC-04-164 21 cm, 8.5" RIC-04-165 25 cm, 10"</p>		<p>RIC-04-173 18 cm, 7" RIC-04-174 21 cm, 8" RIC-04-175 25 cm, 10"</p>		<p>RIC-04-191 17 cm, 6.75"</p>		<p>RIC-04-211 17.5 cm, 7"</p>							
POOTS-SMITH		POTTS-SMITH 1:2		GERALD	GERALD 1:2	CUSHING	CUSHING 1:2	WANGENSTEEN					
<p>RIC-04-160 18 cm, 7" RIC-04-161 21 cm, 8.5" RIC-04-162 25 cm, 10"</p>		<p>RIC-04-170 18 cm, 7" RIC-04-171 21 cm, 8" RIC-04-172 25 cm, 10"</p>		<p>RIC-04-180 18 cm, 7"</p>	<p>RIC-04-190 17 cm, 6.75"</p>	<p>RIC-04-200 17.5 cm, 7"</p>	<p>RIC-04-210 17.5 cm, 7"</p>	<p>RIC-04-220 23 cm, 9"</p>					

TISSUE & DRESSING FORCEPS



TAYLOR 1:2
RIC-04-230
17.5 cm, 7"



GILLIES 1:2
RIC-04-240
15 cm, 6"



RIC-04-250 11.5 cm 4 1/2"
RIC-04-251 13.0 cm 5"
RIC-04-252 14.5 cm 5 1/2"
RIC-04-253 16.0 cm 6 1/4"
RIC-04-254 18.0 cm 7"
RIC-04-255 20.0 cm 8"
RIC-04-256 25.0 cm 10"
RIC-04-257 30.0 cm 12"



RIC-04-260 13 cm, 5"
RIC-04-261 14.5 cm, 5 1/2"
RIC-04-262 16 cm, 6 1/4"



RIC-04-270 13 cm, 5"
RIC-04-271 14.5 cm, 5 1/2"
RIC-04-272 16 cm, 6 1/4"

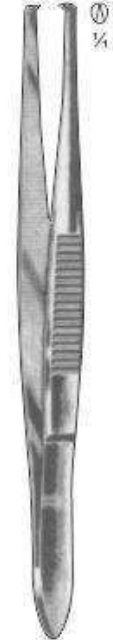

STILLE 1:2
RIC-04-280
15 cm, 6"



STILLE 2:3
RIC-04-290
15 cm, 6"

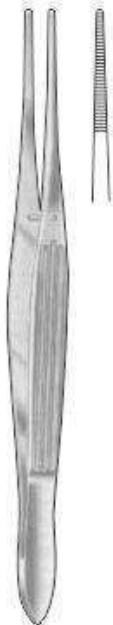

MCINDOE
RIC-04-300 15.0 cm, 6"
Dissecting Forceps non-toothed, serrated jaws.



JEAN 1:2
RIC-04-310 14.0 cm, 5 1/2"
RIC-04-311 18.0 cm, 7"
Dissecting Forceps one into two teeth on serrated jaws.



TREVES 1:2
RIC-04-320 12.5 cm, 5"
RIC-04-321 15.0 cm, 6"
RIC-04-322 18.0 cm, 7"
Dissecting Forceps teeth, on smooth jaws.



RAMSAY 1:2
RIC-04-330 18.0 cm, 7"
Dissecting Forceps one into teeth on serrated jaws. As above but into three teeth.



RIC-04-340 12.5 cm, 5"
RIC-04-341 15.0 cm, 6"
RIC-04-342 18.0 cm, 7"
Dissecting Forceps turn over end, serrated jaws.



FERRIS-SMITH 1:2
RIC-04-350
18 cm, 7"

TISSUE & DRESSING FORCEPS



04-361
18 cm, 7"

FERRIS-SMITH 1:2
RIC-04-360
18 cm, 7"



04-375
12.5cm, 5 1/2"
04-376
15.0cm, 6"
04-377
17.0cm, 6 3/4"
04-378
18.0cm, 7"
04-379
20.0cm, 8"

LANE 1:2
RIC-04-370 12.5cm, 5 1/2"
RIC-04-371 15 cm, 6"
RIC-04-372 17 cm, 6 3/4"
RIC-04-373 18 cm, 7"
RIC-04-374 20 cm, 8"

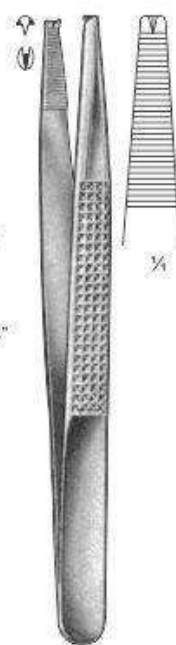

BONNEY 1:2
RIC-04-390
18 cm, 7"



RUSSIAN-MODELL
RIC-04-400 15 cm, 5 1/4"
RIC-04-401 20 cm, 8"
RIC-04-402 25 cm, 10"

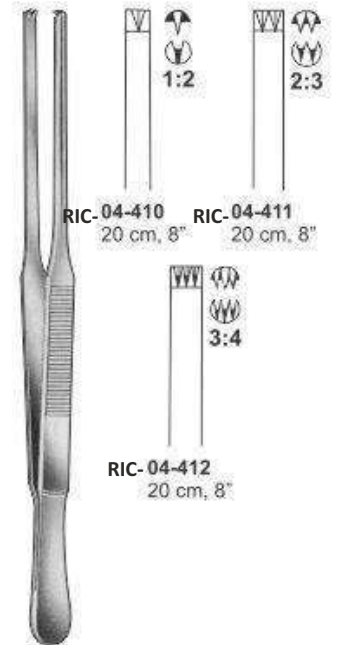

DUEHRSSSEN



DUEHRSSSEN
RIC-04-420
20 cm, 8"



MAYO-RUSSIAN
RIC-04-430 15.5cm, 6"
RIC-04-431 23.0cm, 9"



Grasping, serrated



DAVIS
RIC-04-440
25 cm, 10"



COLLIN-DUVAL



RIC-04-450
20 cm, 8"



RIC-04-451
20 cm, 8"



RIC-04-452
20 cm, 8"



YASARGIL-SAMI
Jaws Spoon-Shaped
24 cm, 9 1/4"



RIC-04-460 3mm
RIC-04-461 5mm
RIC-04-462 7mm



RIC-04-470
14 cm, 5 1/2"
Dressing, Serrated
RIC-04-471
16 cm, 6 1/2"
Dressing, Serrated

LUCAE / ENT

TISSUE & DRESSING FORCEPS

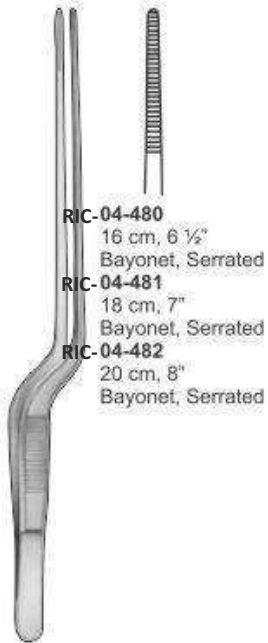

RIC-04-480
 16 cm, 6 1/2"
 Bayonet, Serrated
RIC-04-481
 18 cm, 7"
 Bayonet, Serrated
RIC-04-482
 20 cm, 8"
 Bayonet, Serrated

JANSEN-GRUENWALD



RIC-04-490
 12 cm, 5"
 Tissue, 7:7 Teeth
RIC-04-491
 12 cm, 5"
 Tissue, 9:9 Teeth

ADSON-BROWN

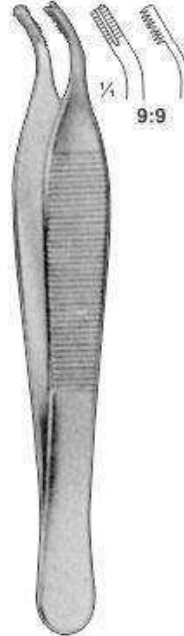

ADSON-BROWN
RIC-04-500
 12 cm, 5"



RIC-04-510
 15 cm, 6"
 Straight, 9:9
 Teeth

BROWN



ADSON / MICRO-ADSON

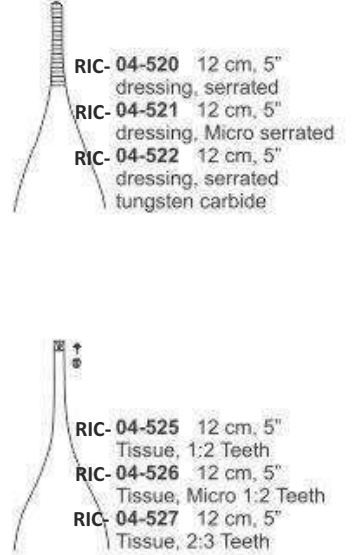

RIC-04-520 12 cm, 5"
 dressing, serrated
RIC-04-521 12 cm, 5"
 dressing, Micro serrated
RIC-04-522 12 cm, 5"
 dressing, serrated tungsten carbide
RIC-04-525 12 cm, 5"
 Tissue, 1:2 Teeth
RIC-04-526 12 cm, 5"
 Tissue, Micro 1:2 Teeth
RIC-04-527 12 cm, 5"
 Tissue, 2:3 Teeth

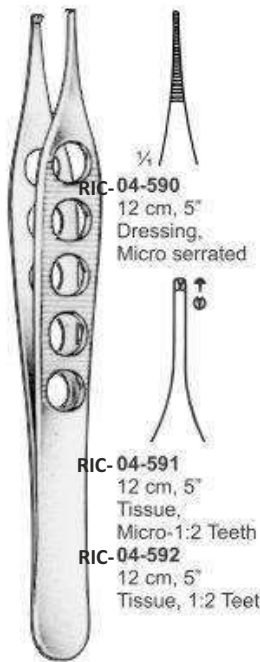

RIC-04-590
 12 cm, 5"
 Dressing, Micro serrated
RIC-04-591
 12 cm, 5"
 Tissue, Micro-1:2 Teeth
RIC-04-592
 12 cm, 5"
 Tissue, 1:2 Teeth

LIGHTWEIGHT-ADSON



DE BAKAY / LIGHTWEIGHT
RIC-04-600
 16 cm, 6 1/2"



RIC-04-610 1.5mm
RIC-04-611 2.0mm
 16 cm, 6 1/2"
RIC-04-612 2.0mm
 16 cm, 6 1/2"

DE BAKAY



MODELL USA



MODELL USA

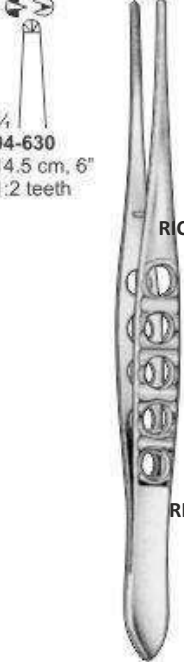

RIC-04-630
 14.5 cm, 6"
 1:2 teeth
MCINDOE
RIC-04-640
 15 cm, 6"

GILLIES
RIC-04-645
 15 cm, 6"
 1:2 teeth

TISSUE & DRESSING FORCEPS T.C

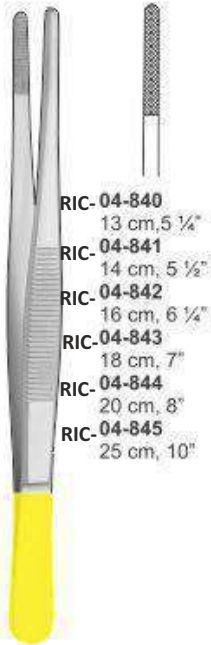

- RIC-04-840
13 cm, 5 1/4"
- RIC-04-841
14 cm, 5 1/2"
- RIC-04-842
16 cm, 6 1/4"
- RIC-04-843
18 cm, 7"
- RIC-04-844
20 cm, 8"
- RIC-04-845
25 cm, 10"

STANDARD



- RIC-04-850
14 cm, 5 1/2"
- RIC-04-851
16 cm, 6 1/4"
- RIC-04-852
18 cm, 7"
- RIC-04-853
20 cm, 8"
- RIC-04-854
25 cm, 20"
- RIC-04-855
30 cm, 12"

STANDARD

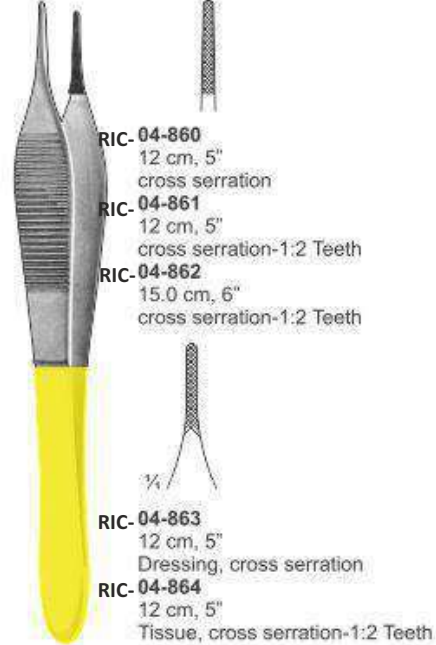

- RIC-04-860
12 cm, 5"
cross serration
- RIC-04-861
12 cm, 5"
cross serration-1:2 Teeth
- RIC-04-862
15.0 cm, 6"
cross serration-1:2 Teeth

- RIC-04-863
12 cm, 5"
Dressing, cross serration
- RIC-04-864
12 cm, 5"
Tissue, cross serration-1:2 Teeth

ADSON



ADSON
RIC-04-870
12 cm, 5"

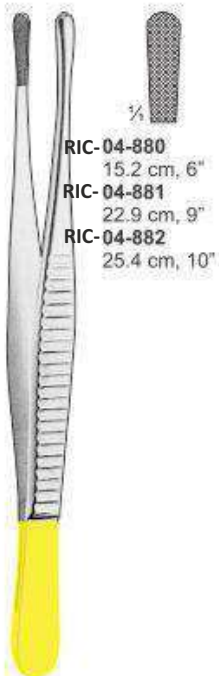

- RIC-04-880
15.2 cm, 6"
- RIC-04-881
22.9 cm, 9"
- RIC-04-882
25.4 cm, 10"

**WANGENSTEEN
TISSUE FORCEPS**



- WANGENSTEEN**
- RIC-04-890 15 cm, 6"
 - RIC-04-891 23 cm, 9"
 - RIC-04-892 25 cm, 10"



**BONNEY
DISSECTING**

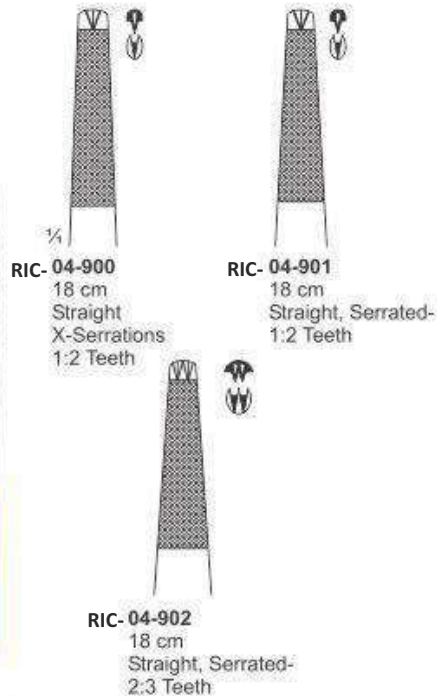

- RIC-04-900
18 cm
Straight
X-Serrations
1:2 Teeth

- RIC-04-901
18 cm
Straight, Serrated-
1:2 Teeth

- RIC-04-902
18 cm
Straight, Serrated-
2:3 Teeth

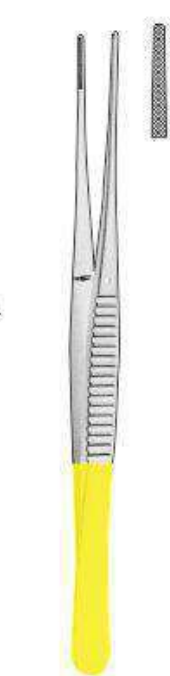

- POTTS-SMITH
FORCEPS**
- RIC-04-910 15 cm, 6"
 - RIC-04-911 18 cm, 7"
 - RIC-04-912 20 cm, 8"
 - RIC-04-913 23 cm, 9"
 - RIC-04-914 25 cm, 10"

HAEMOSTATIC FORCEPS



CARREL
RIC-05-100
8.5 cm, 3 1/4"

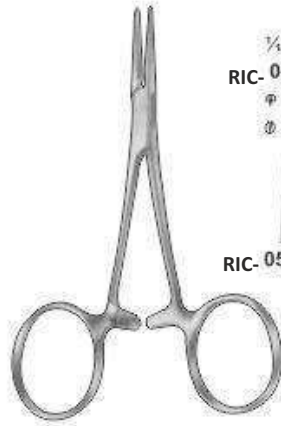

BABY-MOSQUITO (HARTMANN)
RIC-05-110
10.0 cm, 4"



MICRO-HALSTED
RIC-05-120
12.5 cm, 5"

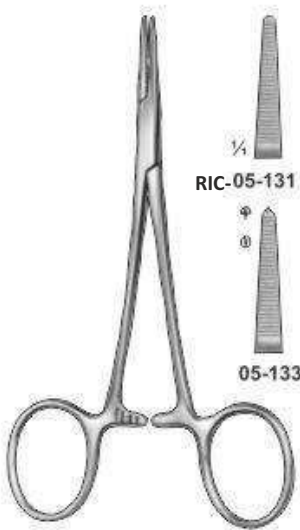
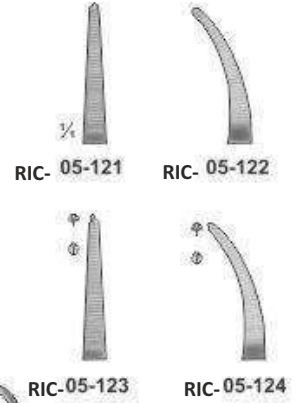

HALSTED-MOSQUITO
RIC-05-130
12.5 cm, 5"

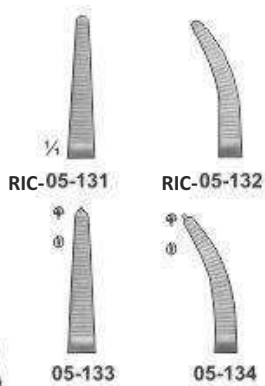

PROVIDENCE-HOSPITAL
RIC-05-140
14.0 cm, 5 1/2"

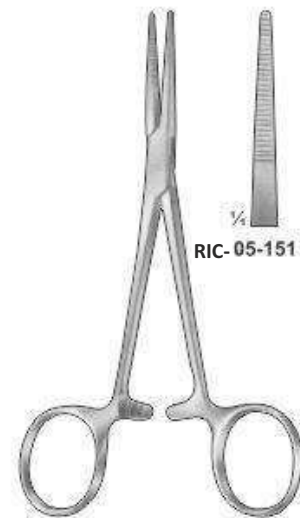

KELLY
RIC-05-150
14.0 cm, 5 1/2"



HAEMOSTATIC FORCEPS

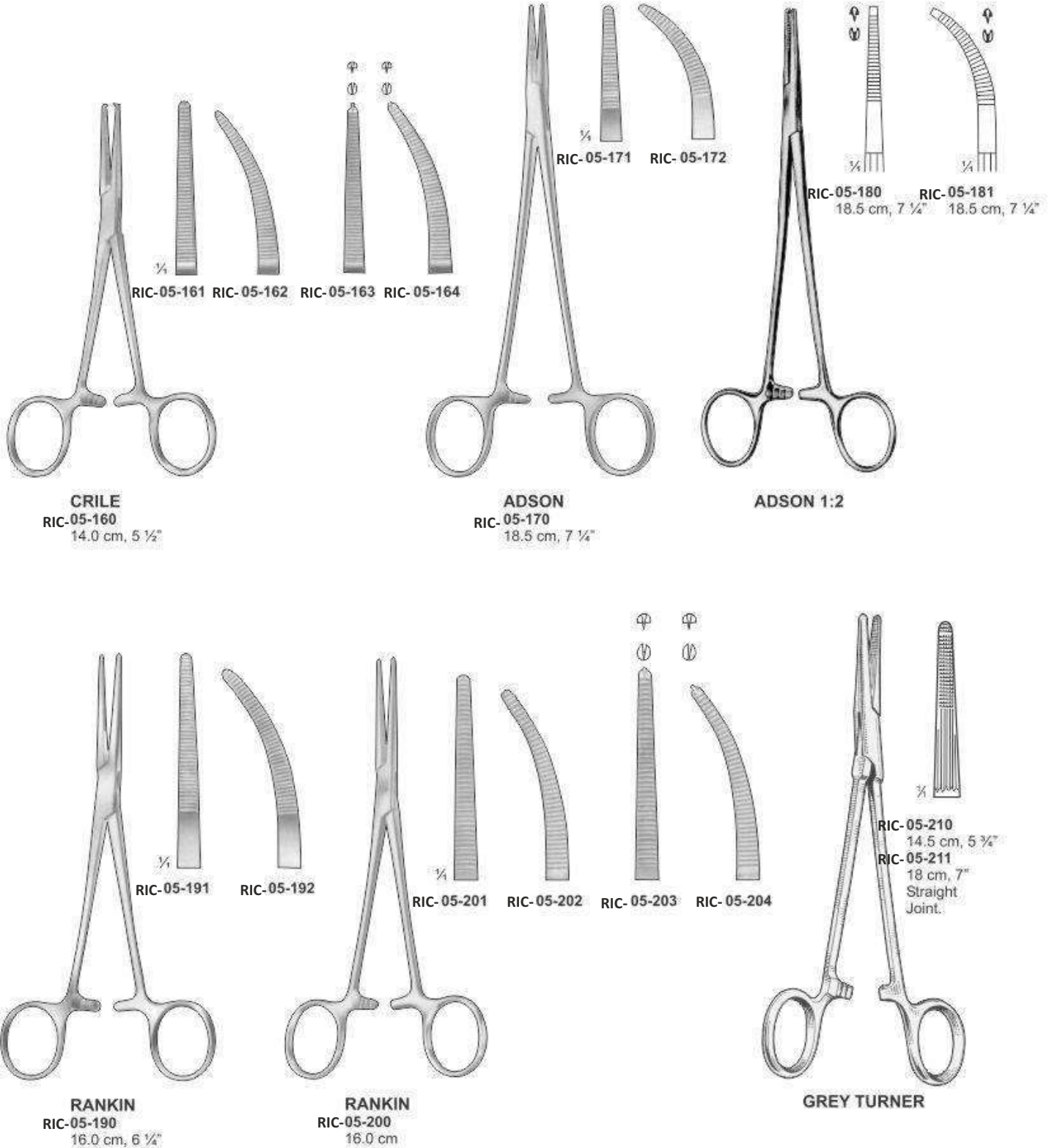

HAEMOSTATIC FORCEPS

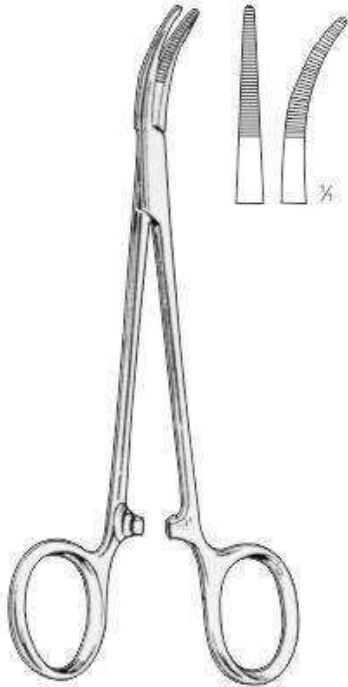

CAIRNS
RIC-05-220
 14.5 cm, 5 3/4"
 Straight, box joint, as above but curved on flat.

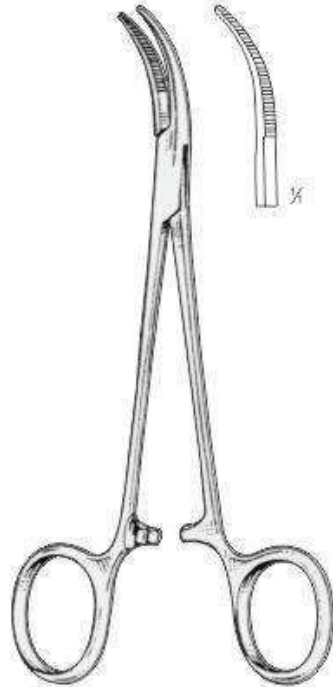

CAIRNS
RIC-05-230
 14.5 cm, 5 3/4"
 curved laterally, joint

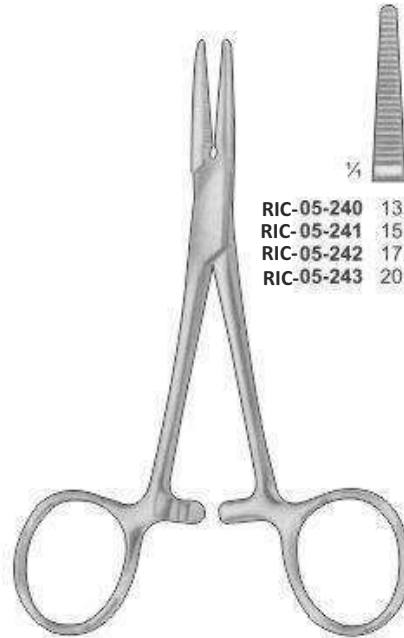

SPENCER-WELLS
 Slender Type

RIC-05-240	13.0 cm	RIC-05-244	13.0 cm
RIC-05-241	15.0 cm	RIC-05-245	15.0 cm
RIC-05-242	17.5 cm	RIC-05-246	17.5 cm
RIC-05-243	20 cm	RIC-05-247	20 cm



PEAN

RIC-05-260	24cm, 9 3/4"	RIC-05-263	24cm, 9 3/4"
RIC-05-261	26cm, 10 1/4"	RIC-05-264	26cm, 10 1/4"
RIC-05-262	28cm, 11"	RIC-05-265	28cm, 11"

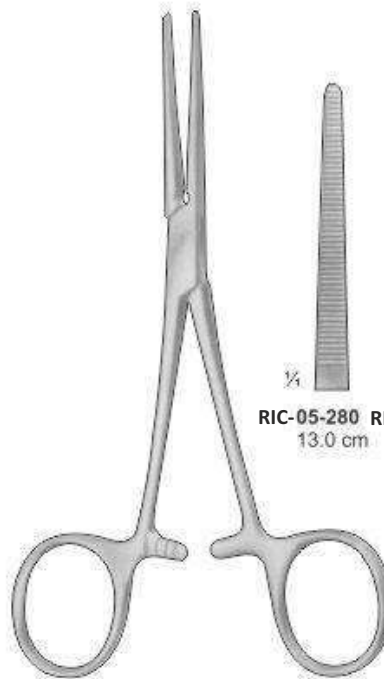

PEAN
 Slender Type

RIC-05-280	RIC-05-281	RIC-05-282	RIC-05-283
13.0 cm	14.0 cm	13.0 cm	14.0 cm

HAEMOSTATIC FORCEPS

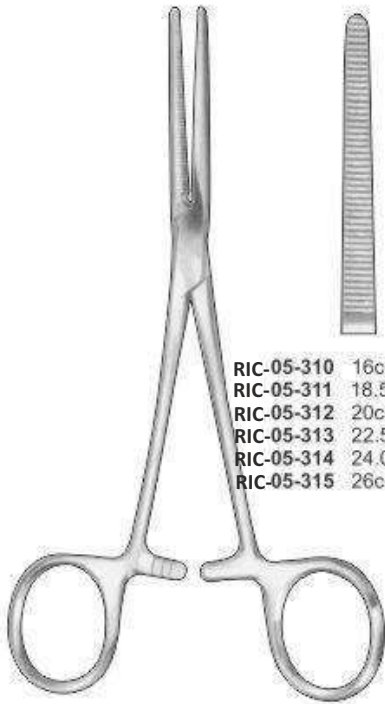

ROCHESTER-PEAN

- | | | | |
|------------|----------------|------------|----------------|
| RIC-05-310 | 16cm, 6 1/4" | RIC-05-316 | 16cm, 6 1/4" |
| RIC-05-311 | 18.5cm, 7 1/4" | RIC-05-317 | 18.5cm, 7 1/4" |
| RIC-05-312 | 20cm, 8" | RIC-05-318 | 20cm, 8" |
| RIC-05-313 | 22.5cm, 9" | RIC-05-319 | 22.5cm, 9" |
| RIC-05-314 | 24.0cm, 9 3/4" | RIC-05-320 | 24.0cm, 9 3/4" |
| RIC-05-315 | 26cm, 10 1/4" | RIC-05-321 | 26cm, 10 1/4" |

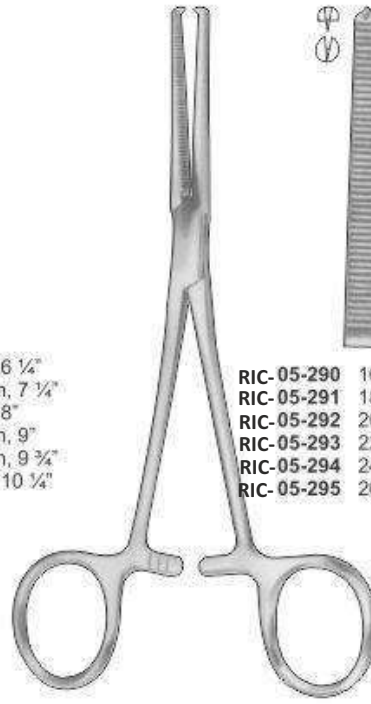

KOCHER-OCHSNER

- | | | | |
|------------|----------------|------------|----------------|
| RIC-05-290 | 16cm, 6 1/4" | RIC-05-296 | 16cm, 6 1/4" |
| RIC-05-291 | 18.5cm, 7 1/4" | RIC-05-297 | 18.5cm, 7 1/4" |
| RIC-05-292 | 20cm, 8" | RIC-05-298 | 20cm, 8" |
| RIC-05-293 | 22.5cm, 9" | RIC-05-299 | 22.5cm, 9" |
| RIC-05-294 | 24.0cm, 9 3/4" | RIC-05-300 | 24.0cm, 9 3/4" |
| RIC-05-295 | 26cm, 10 1/4" | RIC-05-301 | 26cm, 10 1/4" |

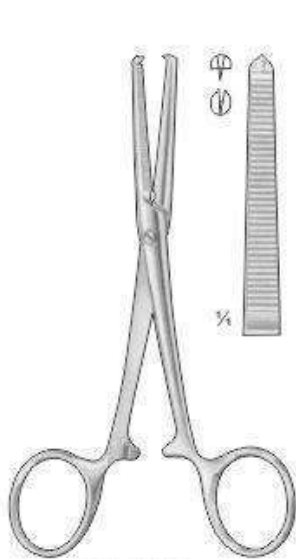

KOCHER
Strong Pattern
RIC-05-330
14.5cm, 5 3/4"

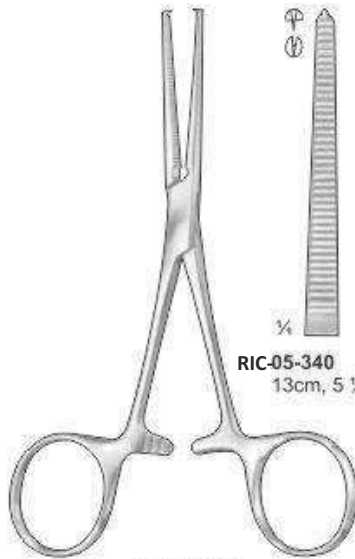

KOCHER

- | | | | | | |
|------------|--------------|------------|--------------|------------|--------------|
| RIC-05-340 | 13cm, 5 1/4" | RIC-05-341 | 14cm, 5 1/2" | RIC-05-342 | 14cm, 5 1/2" |
|------------|--------------|------------|--------------|------------|--------------|

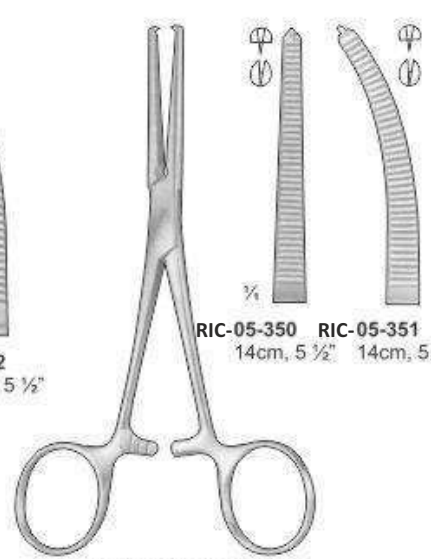

ROCHESTER-OCHSNER

- | | | | |
|------------|--------------|------------|--------------|
| RIC-05-350 | 14cm, 5 1/2" | RIC-05-351 | 14cm, 5 1/2" |
|------------|--------------|------------|--------------|

TOWEL FORCEPS



**JONES /
PERFORATING**
RIC-05-720
9 cm, 3 1/2"
Slight Curve



ENGL. MODELL
RIC-05-730
9 cm, 3 1/2"

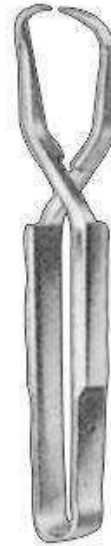

SCHAEDEL
RIC-05-740
9 cm, 3 1/2"



DOYEN
RIC-05-750
18 cm, 7"

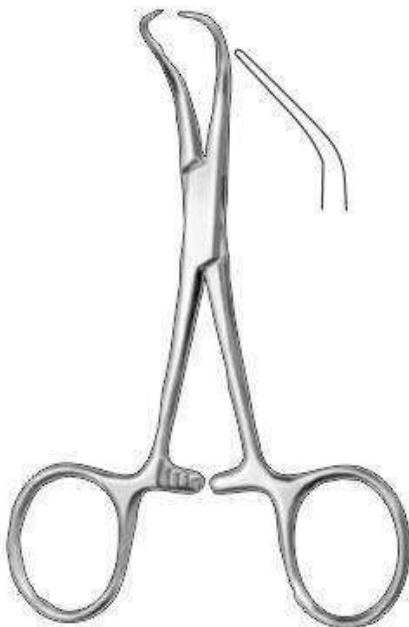

BACKHAUS
RIC-05-760 8 cm, 3"
RIC-05-761 11 cm, 4 1/2"
RIC-05-762 13 cm, 5"
RIC-05-763 15 cm, 5 3/4"
Curved

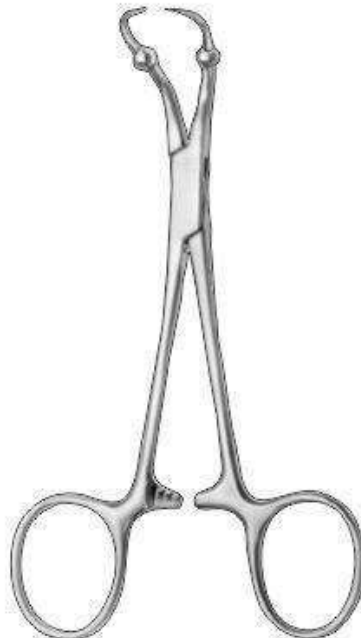

ROEDER
RIC-05-770 13 cm, 5"
RIC-05-771 15 cm, 6"
Curved, Serrated

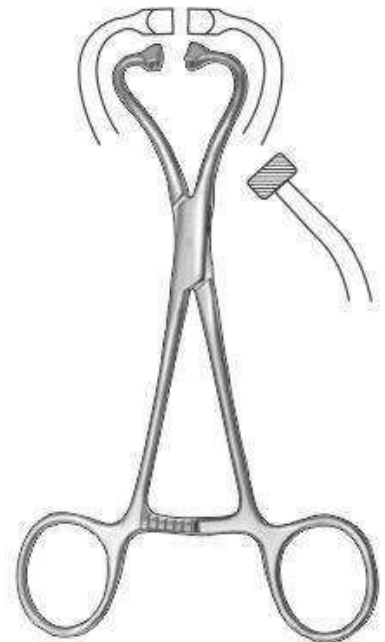

NON-PERFORATING
RIC-05-780 11 cm, 4 1/2"
RIC-05-781 13 cm, 5"

TOWEL FORCEPS

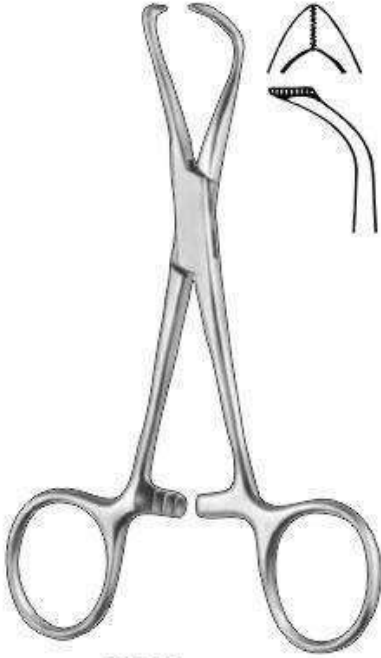

LORNA
 RIC-05-790 10 cm, 4"
 RIC-05-791 11 cm, 4 ½"
 RIC-05-792 13 cm, 5"



BACKHAUS CLIP
 RIC-05-800 11 cm, 4 ¼"
 with clip for tubing or
 cable

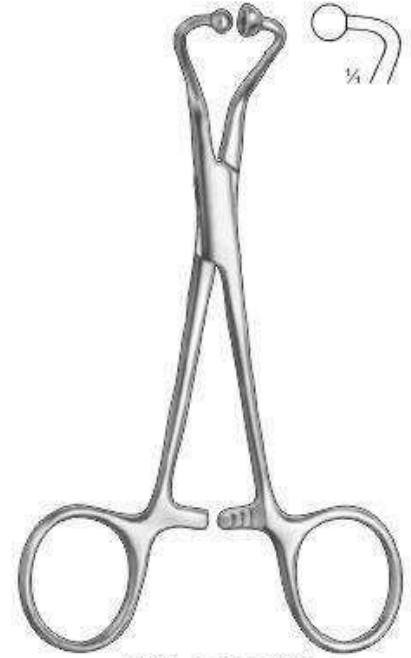

BALL & SOCKET
 RIC-05-810 13 cm, 5"
 Non-perforating

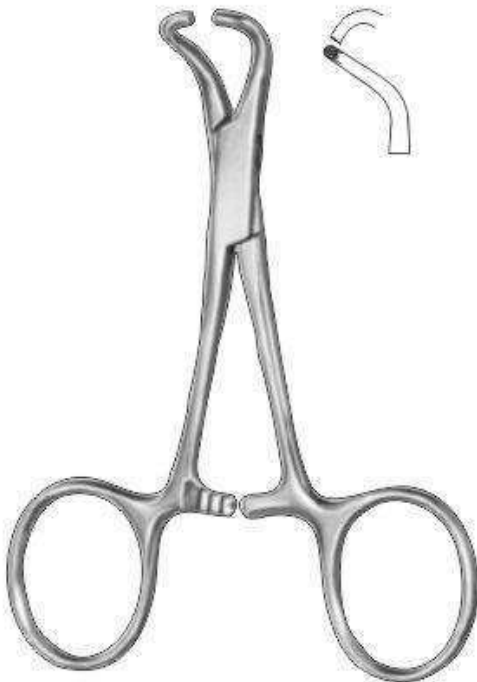

TOHOKU
 RIC-05-820 10cm, 4"
 RIC-05-821 13cm, 5"
 Non-Perforating

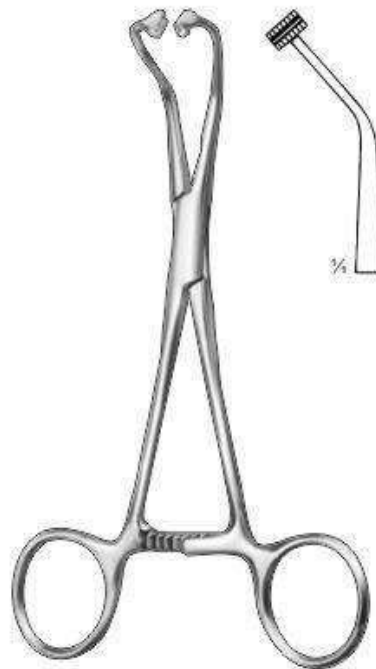

PEERS-BERTMAN
 RIC-05-830
 14.5 cm, 5 ¾"
 Serrated



BERNHARD
 RIC-05-840
 16.5 cm, 6 ½"

SPONGE FORCEPS

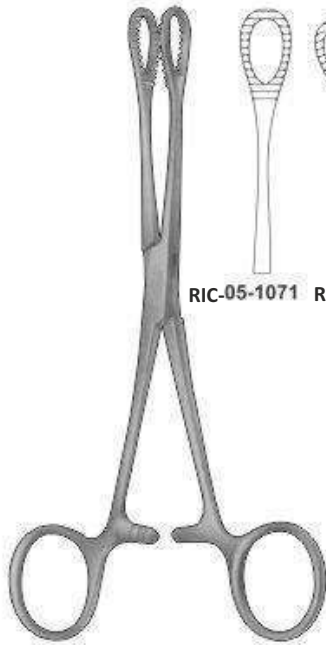

FOERSTER-BALLEGER
RIC-05-1070
18cm, 7"

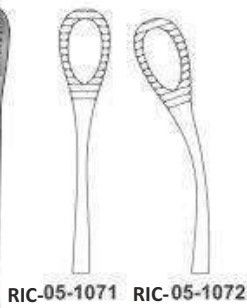

RIC-05-1071 RIC-05-1072

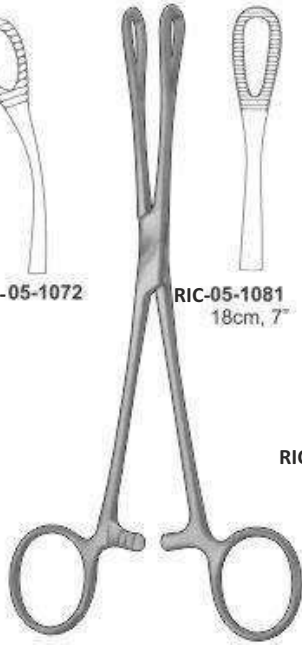

RAMPLEY
RIC-05-1080



RIC-05-1081
18cm, 7"

RIC-05-1082
25cm, 10"



FOERSTER

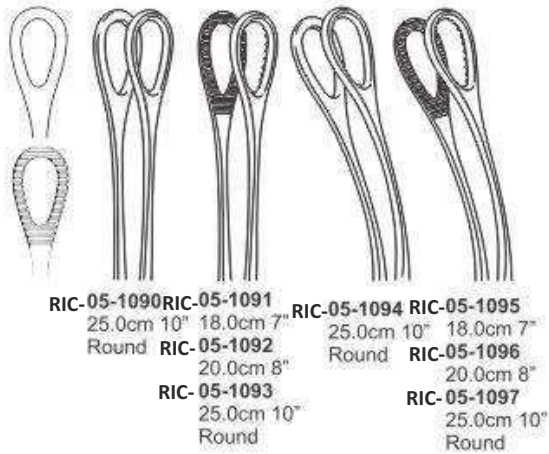

RIC-05-1090 25.0cm 10" Round
RIC-05-1091 18.0cm 7" Round
RIC-05-1092 20.0cm 8" Round
RIC-05-1093 25.0cm 10" Round
RIC-05-1094 25.0cm 10" Round
RIC-05-1095 18.0cm 7" Round
RIC-05-1096 20.0cm 8" Round
RIC-05-1097 25.0cm 10" Round



COLLIN
RIC-05-1110



RIC-05-1111 19.5cm, 7 3/4"
RIC-05-1112 23cm, 9"

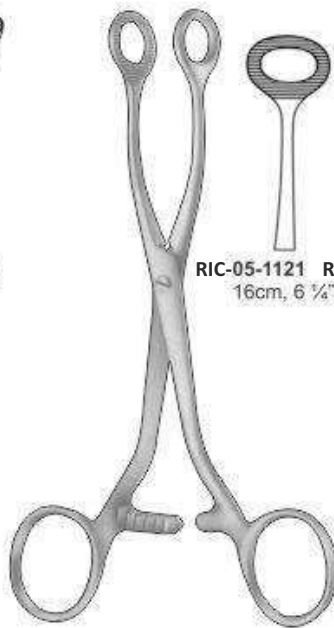

COLLIN
RIC-05-1120



RIC-05-1121 16cm, 6 1/4"
RIC-05-1122 16cm, 6 1/4"
RIC-05-1123 17cm, 6 3/4"

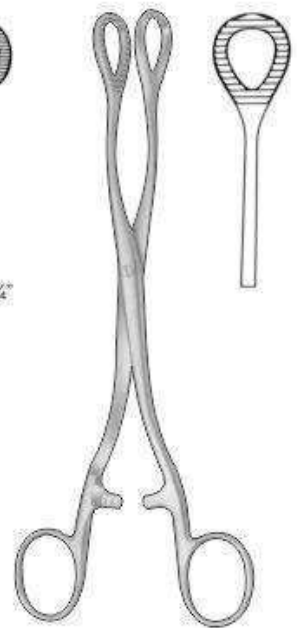

HEYWOOD-SMITH
RIC-05-1130
20cm, 8"

NEEDLE HOLDERS

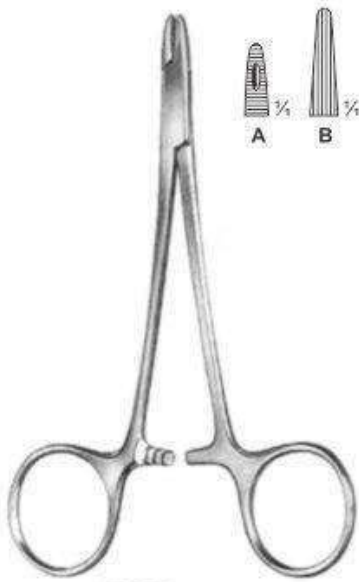

DERF
 RIC-06-100 12 cm, 5" A
 RIC-06-101 12 cm, 5" B



COLLIER
 RIC-06-110 12.5 cm

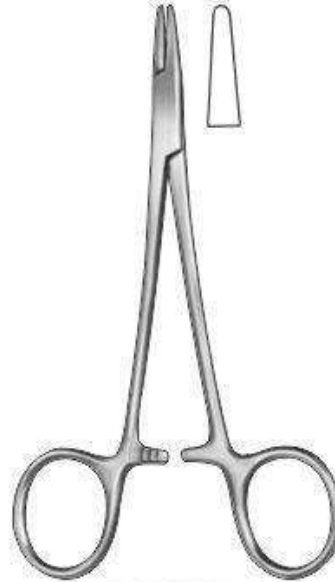

WEBSTER
 RIC-06-120 13cm

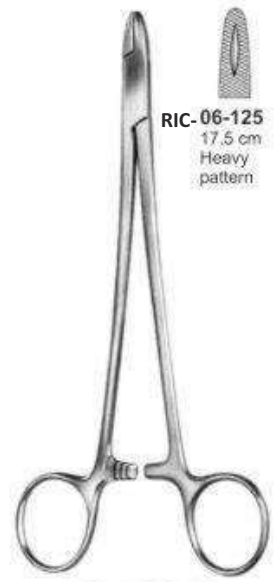

M.G. HOSPITAL



MAYO-HEGAR

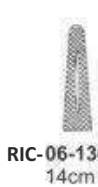

RIC-06-130
14cm



RIC-06-131
16cm

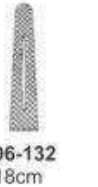

RIC-06-132
18cm



RIC-06-133
20cm

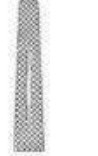

RIC-06-134
24cm

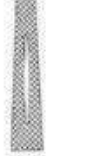

RIC-06-135
26cm



RIC-06-136
30cm



CRILE-WOOD
 RIC-06-140 150cm



CRILE-MURRAY
 RIC-06-150 15 cm

NEEDLE HOLDERS



WRIGHT
RIC-06-160 13cm

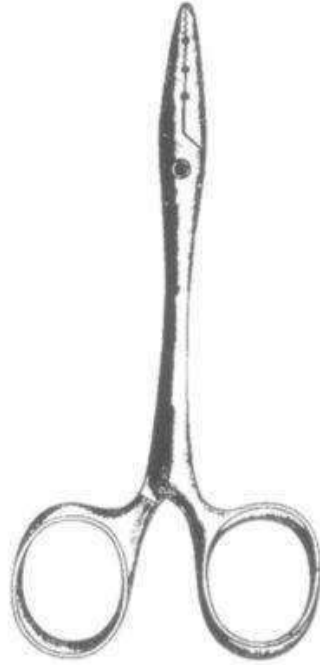

BRUCE-CLARKE
RIC-06-170 12.5cm

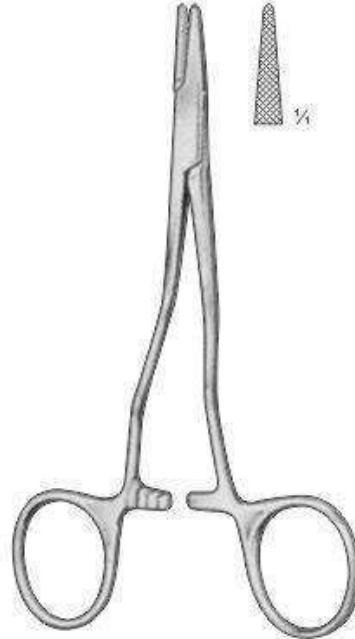

KILNER
RIC-06-180 13.5 cm

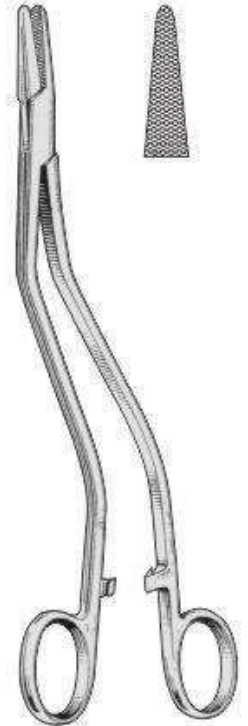

THOMSON WALKER
RIC-06-190 20cm



BOZEMANN
RIC-06-200 20cm



METZENBAUM
RIC-06-210 18cm



FINOCCHIETTO
RIC-06-220 27cm



WANGENSTEEN
RIC-06-230 27cm

NEEDLE HOLDERS



MASSON
RIC-06-240
27 cm, 10 3/4"



SAROT
RIC-06-250
27cm

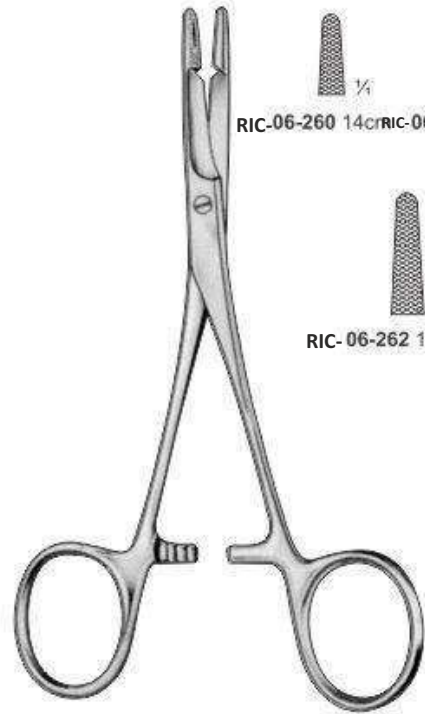

RIC-06-260 14cm RIC-06-261 16.5 cm

RIC-06-262 19 cm

OLSEN



GILLIES
RIC-06-270 16 cm



MATHIEU



RIC-06-280 11cm
RIC-06-281 14cm
RIC-06-282 17cm



MATHIEU

RIC-06-290 14cm
RIC-06-291 17cm
RIC-06-292 20cm
RIC-06-293 24cm



LANGENBECK
RIC-06-300 18.5cm

NEEDLE HOLDERS T.C.



RIC-06-440
12 cm
Mini profile

DERF



RIC-06-451 13 cm
Mini profile

RIC-06-452 14.5 cm
Mini profile

HEGAR-BAUMGARTNER
RIC-06-450



RIC-06-461 13 cm
Smooth jaw

RIC-06-462 13 cm
Mini profile

HALSEY
RIC-06-460



RIC-06-470
12 cm, 13 cm
Two Sizes
Smooth jaw

WEBSTER

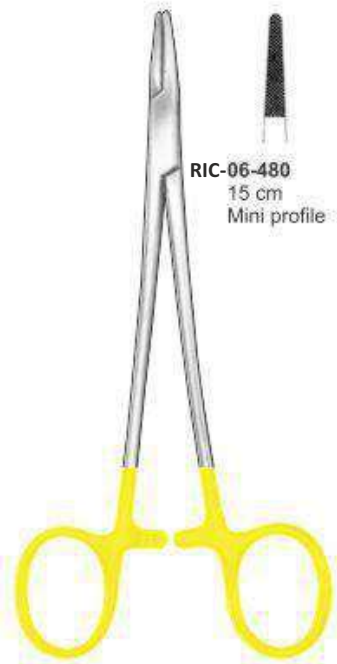

RIC-06-480
15 cm
Mini profile

CRILE-WOOD



RIC-06-490
13 cm
Mini profile

KILNER

NEEDLE HOLDERS T.C.



RIC-06-500

WEBSTER
RIC-06-501
13 cm
Mini profile

CRILE-WOOD
RIC-06-502
15 cm



CRILE-WOOD

RIC-06-510
20.5 cm
Mini profile



SAROT
06-520

RIC-06-521
18 cm
Standard profile

RIC-06-522
20 cm
Standard profile

RIC-06-523
26 cm
Standard profile

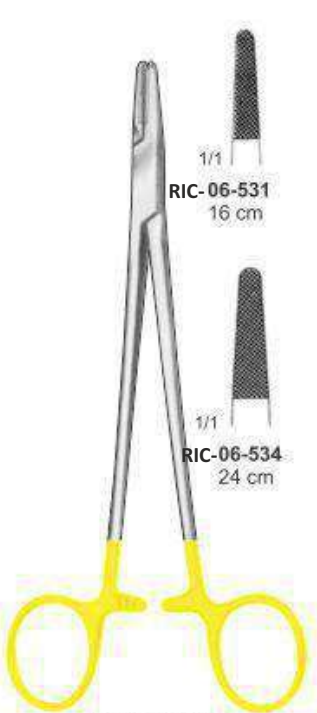

MAYO-HEGAR
RIC-06-530
Standard profile

RIC-06-531
16 cm

RIC-06-532
18 cm

RIC-06-533
20 cm

RIC-06-534
24 cm

RIC-06-535
26 cm

RIC-06-536
30 cm

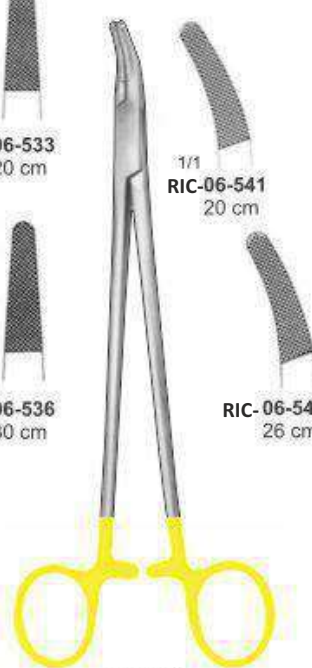

HEANEY
RIC-06-540
Standard profile

RIC-06-541
20 cm

RIC-06-542
24 cm

RIC-06-543
26 cm



DeBAKEY
RIC-06-550
Delicate pattern
mini profile

RIC-06-551
18 cm

RIC-06-552
20 cm

RIC-06-553
23 cm

RIC-06-554
26 cm

RIC-06-555
31 cm

NEEDLE HOLDERS T.C.

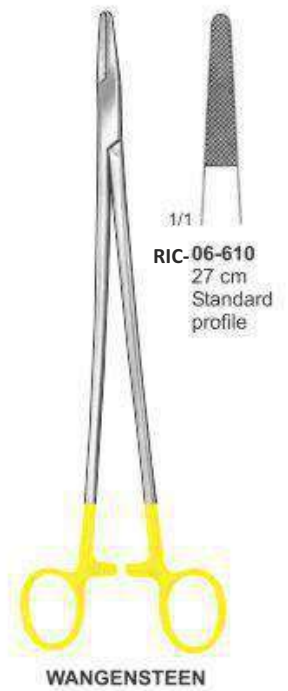
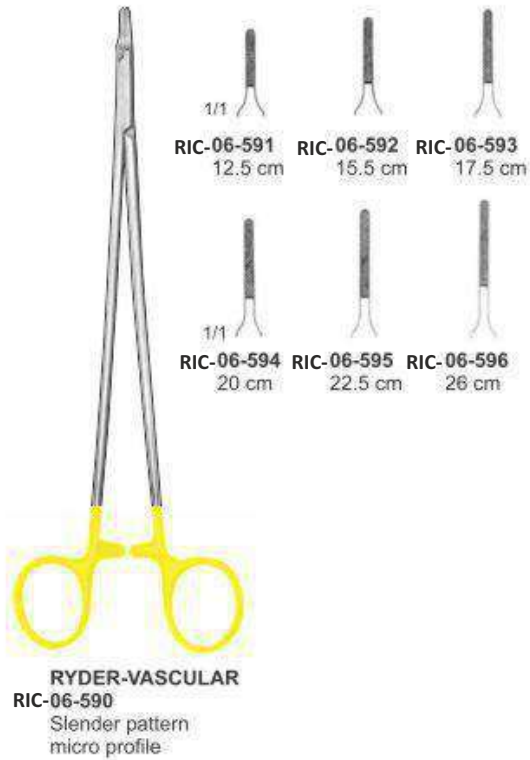
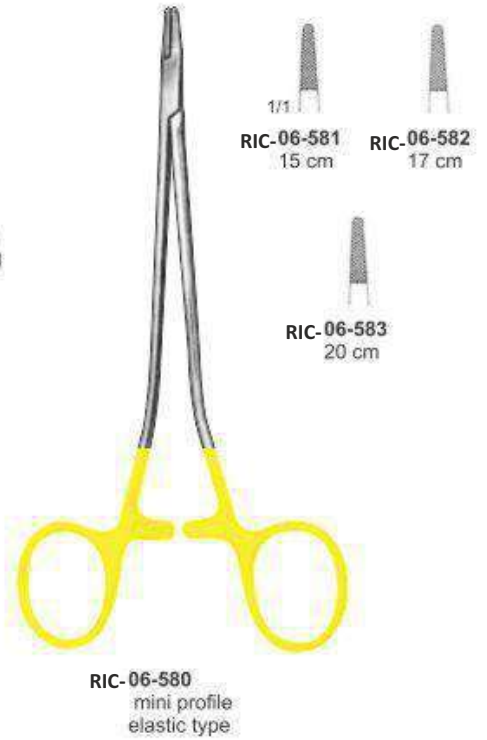
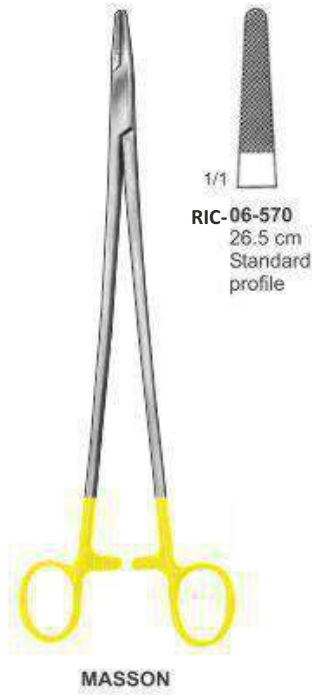
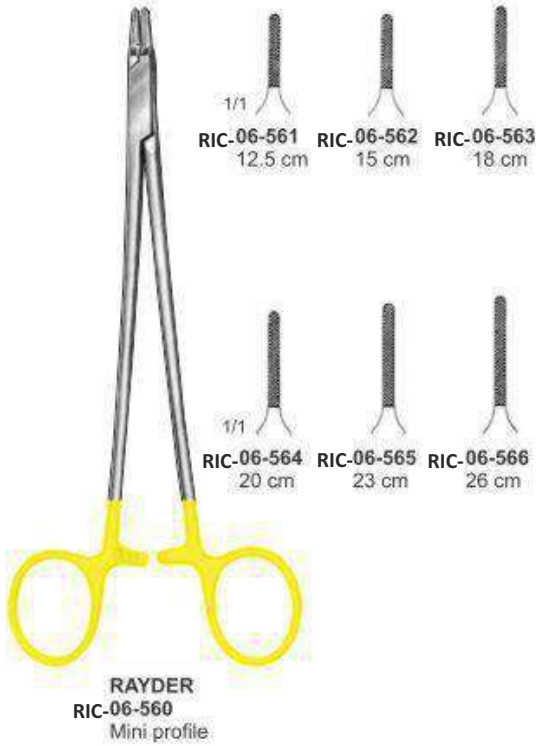

NEEDLE HOLDERS T.C.

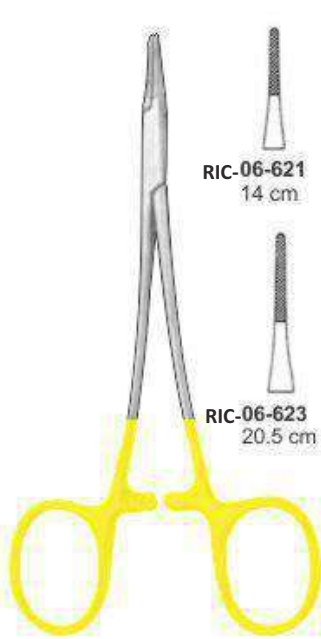

HEGAR-VASCULAR
RIC-06-620
Micro profile

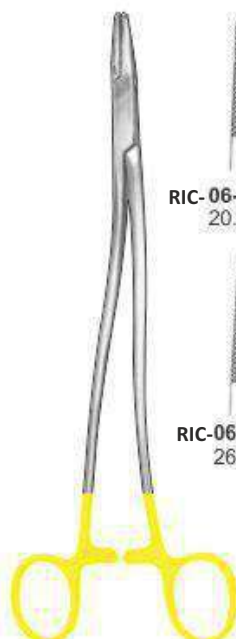

BOZEMANN
RIC-06-630
Standard profile



HEGAR
RIC-06-640
Standard profile



STRATTE
RIC-06-650
Standard profile

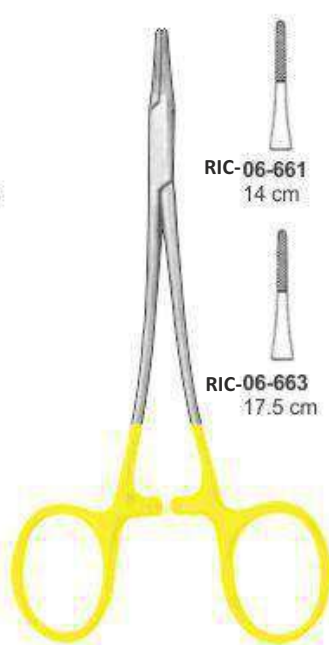

MARTINI
RIC-06-660
Slender pattern,
micro profile



OLSEN-HEGAR
RIC-06-670
Standard profile



NEEDLE HOLDERS T.C.



FOSTER-GILLIES

RIC-06-680
11 cm
Smooth jaw



GILLIES-MINI

RIC-06-690
15 cm
Mini profile

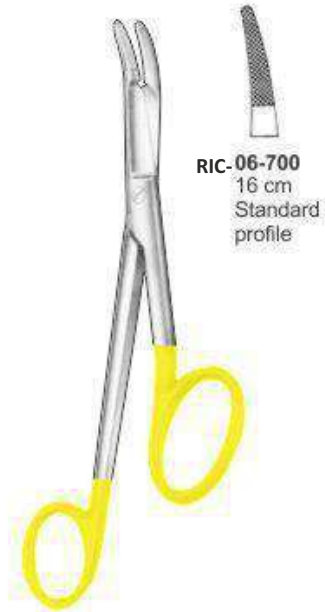

GILLIES

RIC-06-700
16 cm
Standard profile



MICROVASCULAR
RIC-06-710
Slender pattern,
micro profile



RIC-06-711
14 cm



RIC-06-712
17.5 cm



RIC-06-713
20 cm



RIC-06-714
23 cm



MARTINI
RIC-06-720
Slender pattern,
smooth jaw



RIC-06-721
14 cm



RIC-06-722
16 cm



RIC-06-723
17.5 cm



RIC-06-724
20 cm

NEEDLE HOLDERS T.C.

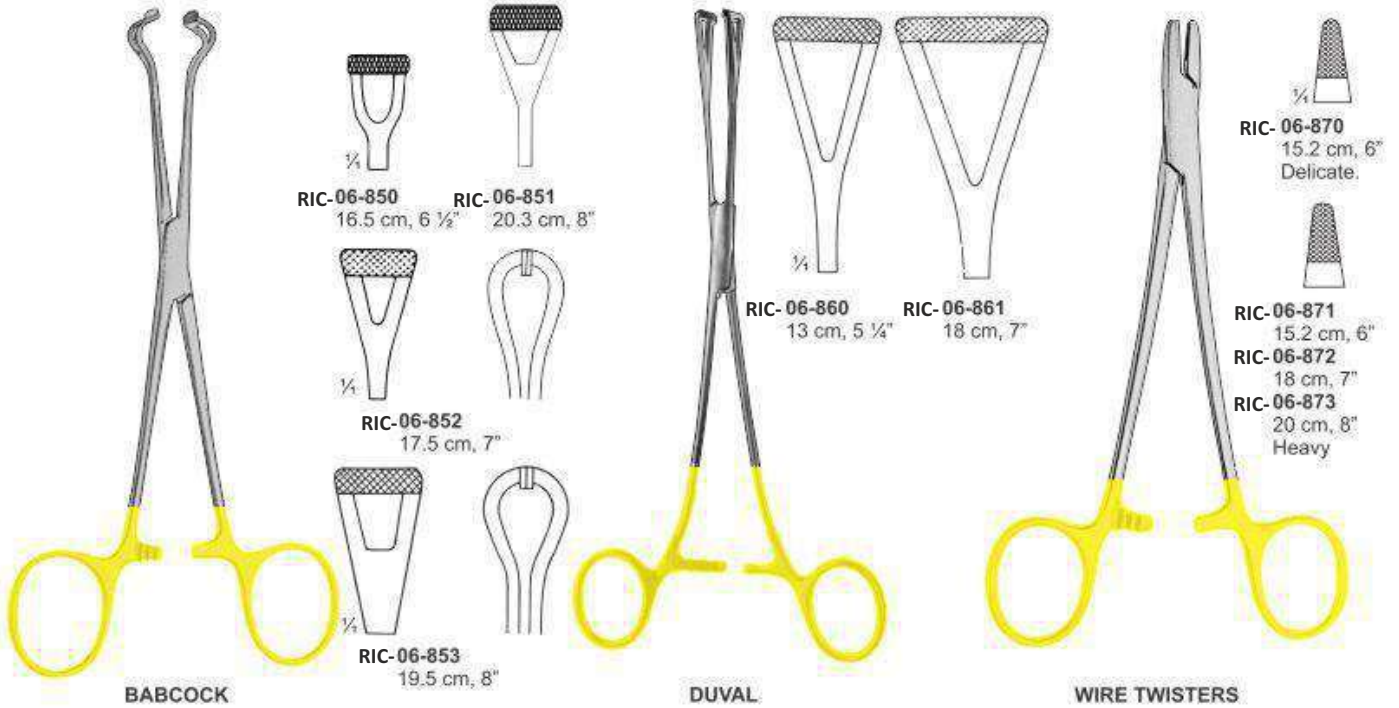

STERNUM
RIC-06-880
17.5 cm, 7"
Wire Twister.

WIRE TIGHTENING PLIERS
RIC-06-890
18 cm, 7"

COOLEY-BAUMGAFTEN WIRE TWISTER
RIC-06-900
20.3 cm, 8"
Extra heavy needle holder designed for twisting of wire and placement of retention suture. Heavy, blunt jaws.

RUBIO WIRE TWISTER
RIC-06-910
12.7 cm, 5 1/4"

HOOKLETS, RETRACTORS

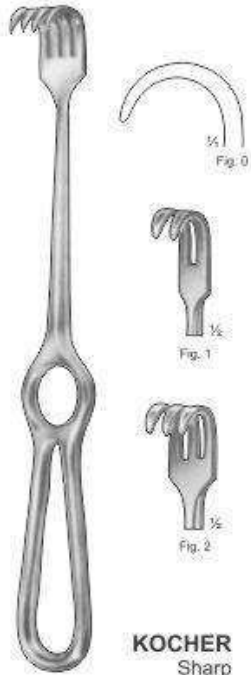

KOCHER
Sharp

- 07-260 22 cm, 8 3/4" 15 x 10 mm Fig. 1
- 07-261 22 cm, 8 3/4" 15 x 15 mm Fig. 2
- 07-262 22 cm, 8 3/4" 15 x 20 mm Fig. 3
- 07-263 22 cm, 8 3/4" 15 x 30 mm Fig. 4
- 07-264 22 cm, 8 3/4" 15 x 40 mm Fig. 5



Fig. 3



Fig. 1



Fig. 2



Fig. 4



Fig. 5



KOCHER
Blunt

- 07-270 22 cm, 8 3/4" 15 x 10 mm Fig. 1
- RIC-07-271 22 cm, 8 3/4" 15 x 15 mm Fig. 2
- RIC-07-272 22 cm, 8 3/4" 15 x 20 mm Fig. 3
- RIC-07-273 22 cm, 8 3/4" 15 x 30 mm Fig. 4
- RIC-07-274 22 cm, 8 3/4" 15 x 40 mm Fig. 5

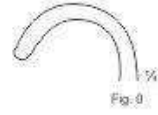

Fig. 1



Fig. 2



Fig. 3



Fig. 4



Fig. 5



SENN-MUELLER
RIC-07-280
18 x 6 mm
16 cm, 6 1/4"
sharp



MEYERDING
18 cm, 7"



RIC-07-290
18 x 7 mm
Blunt



RIC-07-291
16 x 5 mm
Toothed



RIC-07-292
7 x 4 mm
Toothed



RIC-07-293
10 x 3 mm
Blunt



RIC-07-294
7 x 4 mm
Saddle Shaped



RIC-07-295
10 x 4 mm
Sharp



LANGENBECK
RIC-07-300
22 cm, 8 1/2"



RIC-07-301
25 x 6 mm



RIC-07-302
25 x 6 mm



RIC-07-303
35 x 11 mm



RIC-07-304
35 x 11 mm



RIC-07-305
41 x 11 mm



RIC-07-306
41 x 11 mm



RIC-07-307
70 x 14 mm



LANGENBECK
RIC-07-320
22 cm, 8 1/2"

RETRACTORS

<p>RIC-07-330 23 x 20 mm</p> <p>RIC-07-331 30 x 29 mm</p> <p>RIC-07-332 37 x 37 mm</p>	<p>RICHARDSON 24.0 cm 9.5"</p>	<p>RIC-07-340 38 x 37 mm</p> <p>RIC-07-341 22 x 21 mm</p> <p>RIC-07-342 39 x 30 mm</p> <p>RIC-07-343 64 x 43 mm</p>	<p>RICHARDSON-EASTMAN RIC-07-344 25.0 cm 10", Set of 2 piece</p>	<p>KOCHER RIC-07-350 40 x 10 mm 22 cm, 8 3/4" RIC-07-351 40 x 15 mm 22 cm, 8 3/4" RIC-07-352 40 x 20 mm 22 cm, 8 1/2"</p>	<p>FRITSCH RIC-07-360 35 x 40 mm 24 cm, 9 1/2"</p>
<p>MORRIS RIC-07-370 90mm RIC-07-371 100mm RIC-07-372 115mm</p>	<p>MORRIS RIC-07-380 48mm</p>	<p>LANGENBECK RIC-07-390 22 x 6 mm RIC-07-391 44 x 13 mm</p>	<p>DURHAM RIC-07-400 13 mm RIC-07-401 19 mm</p>	<p>CZERNY RIC-07-410 20 mm</p>	

RETRACTORS

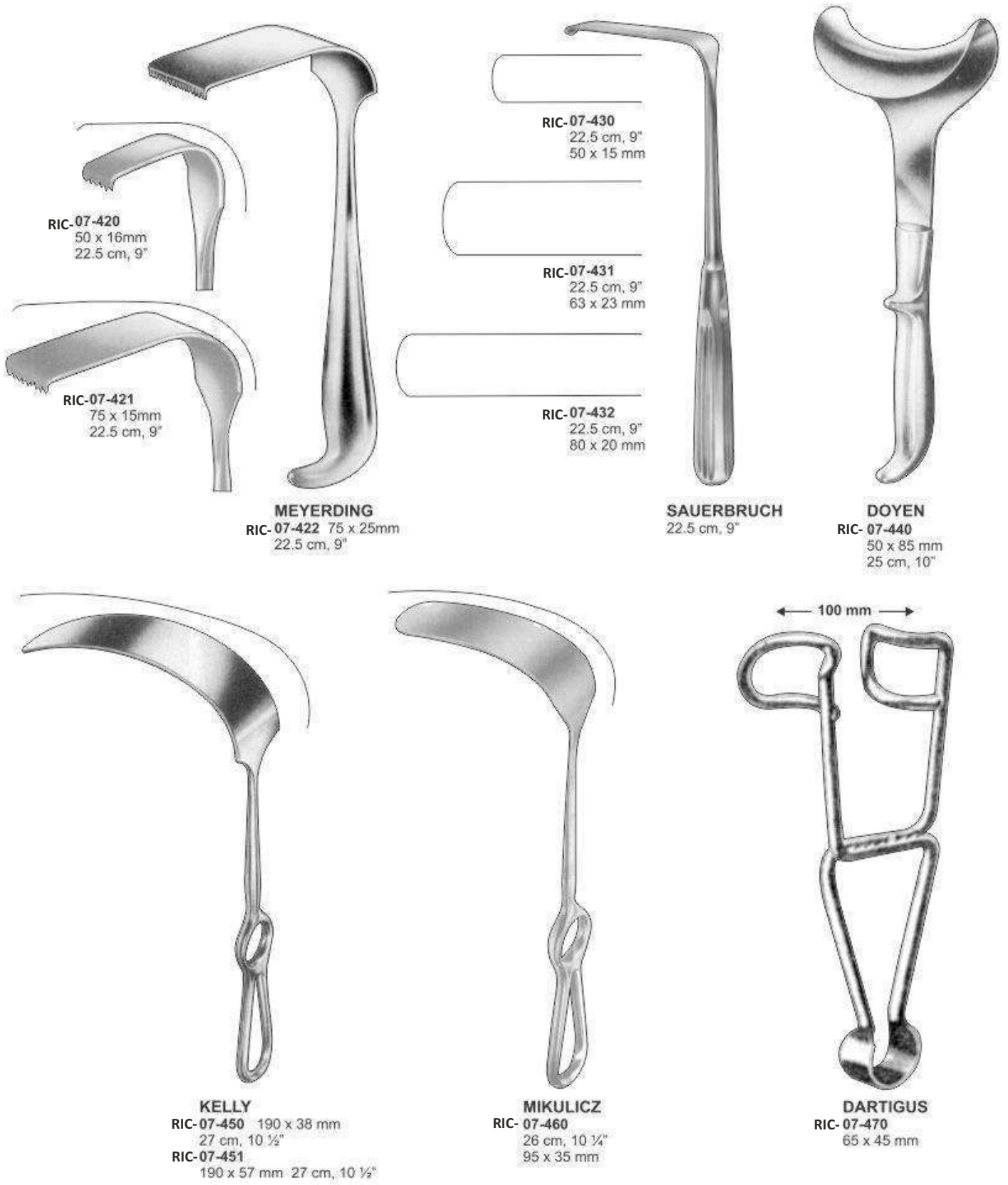

RIC-07-420
50 x 16mm
22.5 cm, 9"

RIC-07-421
75 x 15mm
22.5 cm, 9"

MEYERDING
RIC-07-422 75 x 25mm
22.5 cm, 9"

RIC-07-430
22.5 cm, 9"
50 x 15 mm

RIC-07-431
22.5 cm, 9"
63 x 23 mm

RIC-07-432
22.5 cm, 9"
80 x 20 mm

SAUERBRUCH
22.5 cm, 9"

DOYEN
RIC-07-440
50 x 85 mm
25 cm, 10"

KELLY
RIC-07-450 190 x 38 mm
27 cm, 10 1/2"
RIC-07-451
190 x 57 mm 27 cm, 10 1/2"

MIKULICZ
RIC-07-460
26 cm, 10 1/4"
95 x 35 mm

DARTIGUS
RIC-07-470
65 x 45 mm

RETRACTORS

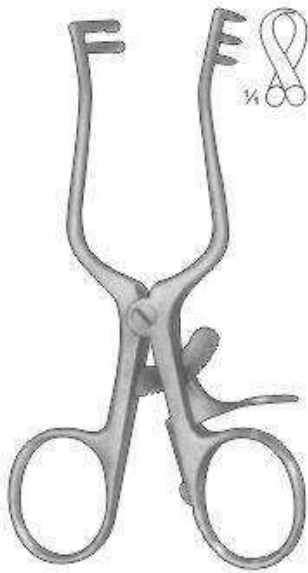

WEITLANER
RIC-07-570
Sharp
11.0 cm

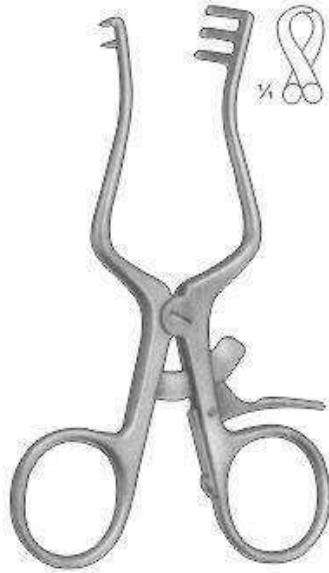

WEITLANER
RIC-07-580
Semi-Sharp
11.0 cm

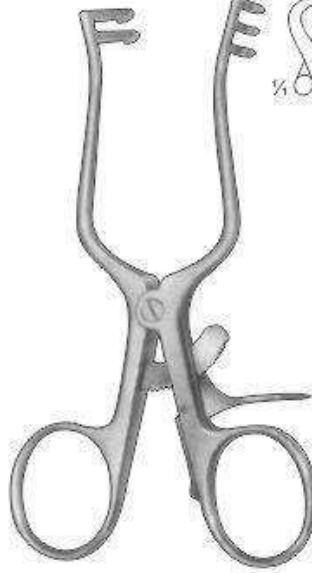

WEITLANER
RIC-07-590
Blunt
11.0 cm



WEITLANER
RIC-07-600
Sharp
13.0 cm



WEITLANER
RIC-07-610
Semi-Sharp
13.0 cm



WEITLANER
RIC-07-620
Blunt
13.0 cm



MILLIGAN
RIC-07-630
18.5 mm x 20 mm
Blunt, 3:3
13 cm, 5"



JANSEN
RIC-07-640 10 cm, 4"
Sharp 3:3
RIC-07-641 10 cm, 4"
Blunt 3:3



GELPI-LOKTITE
RIC-07-650
18 cm, 7"

RETRACTORS



BECKMANN-ADSON
RIC-07-661
 31 cm, 12 1/4"
 Semi-Sharp



ADSON
RIC-07-670
 32 cm, 12 1/2"
 Semi-Sharp



BECKMANN-EATON
RIC-07-680
 32 cm, 12 1/2"
 Sharp

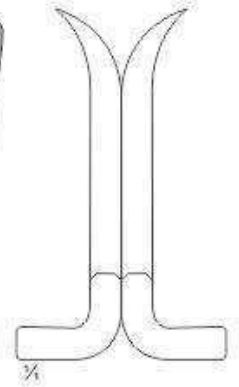

BECKMANN-ADSON
RIC-07-660
 31 cm, 12 1/4"
 Sharp



HENLEY

RIC-07-690
 16 cm, 6 1/4"
 3 : 4 mm
 blunt

RIC-07-691
 16 cm, 6 1/4"
 3 : 4 mm
 sharp

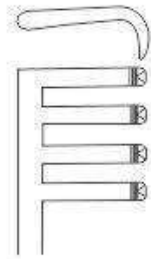
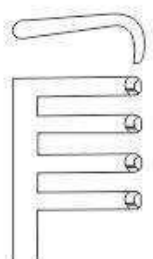

MISKIMON
RIC-07-700 22 cm, 8 3/4"
 33 mm x 38 mm
 Sharp, 7:7



ADSON-BABY
RIC-07-711
 16 cm, 6 1/4" sharp
 3 x 4 teeth
 13 mm



ADSON-BABY
RIC-07-712
 16 cm, 6 1/4" blunt
 3 x 4 teeth
 13 mm



RETRACTORS

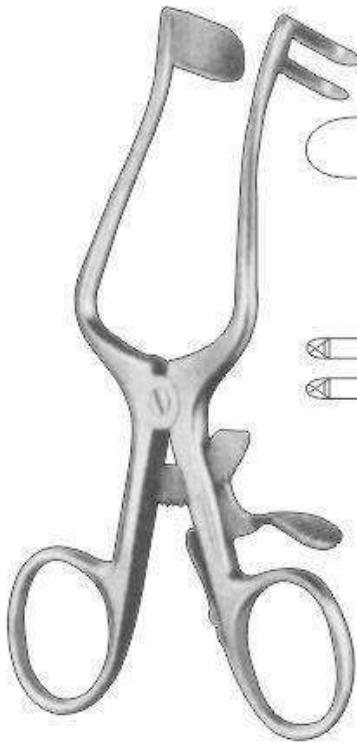

PLESTER

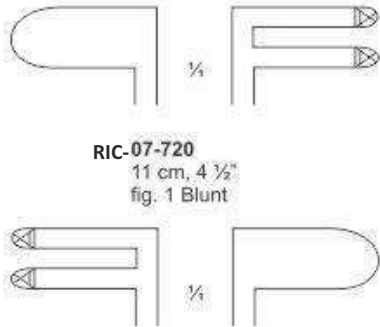

RIC-07-720
11 cm, 4 1/2"
fig. 1 Blunt

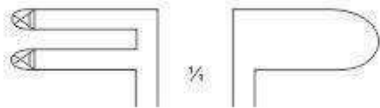

RIC-07-721
11 cm, 4 1/2"
fig. 2 Blunt

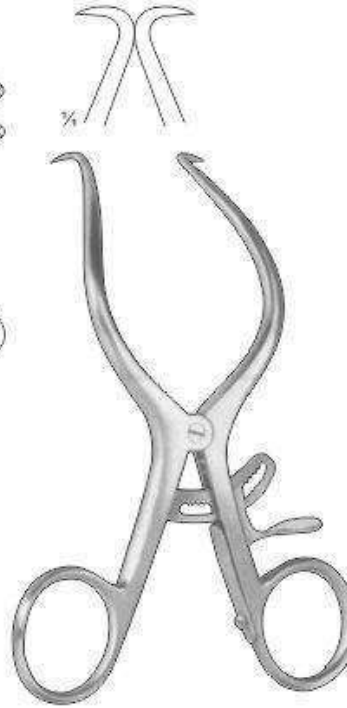

GELPI
Vaginal Retractor
RIC-07-730
13.5 cm, 5"



GELPI
Skin- and Vaginal Retractor
RIC-07-740
17.5 cm, 7"



CLOWARD modif.
RIC-07-750
Spreader Only



RIC-07-751



RIC-07-752



RIC-07-753



RIC-07-754



RIC-07-755



RIC-07-756



RIC-07-757

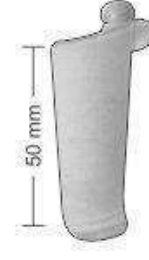

RIC-07-758



RIC-07-759



RIC-07-760

PERIOSTEAL ELEVATORS

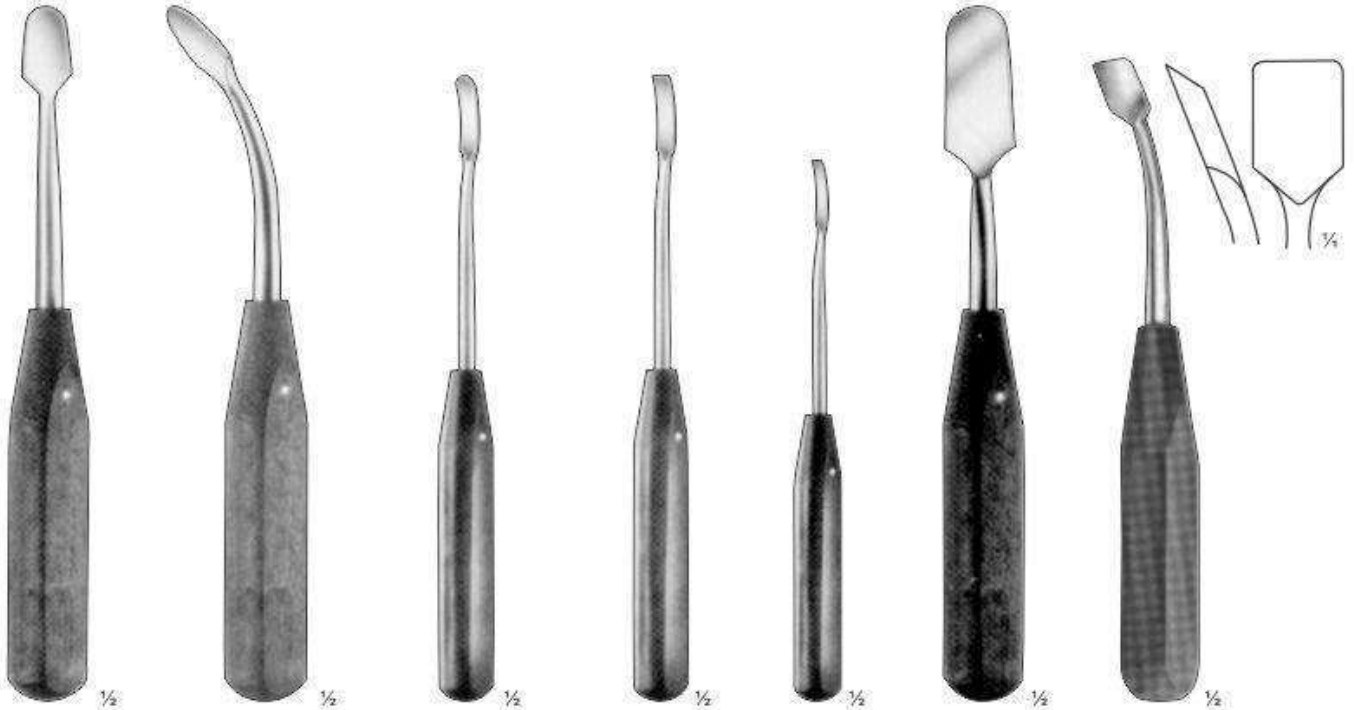

RIC-09-1460
20 cm, 8"
Medium straight
blade round edge,
width 14 mm

RIC-09-1470
20 cm, 8"
Medium curved
blade round edge,
width 14 mm

RIC-09-1480
18 cm, 7"
Small curved
blade round edge,
width 6 mm

RIC-09-1490
18 cm, 7"
Small curved
blade straight edge,
width 6 mm

RIC-09-1500
18 cm, 7"
Extra small
curved blade
round edge,
width 3 mm

RIC-09-1510
20 cm, 8"
Large straight blade
round edge,
width 20 mm

Medium Blade
Straight Edge, 14 mm
RIC-09-1520
Straight 18.5 cm, 7 1/2"
RIC-09-1521
Curved 18.5 cm, 7 1/2"

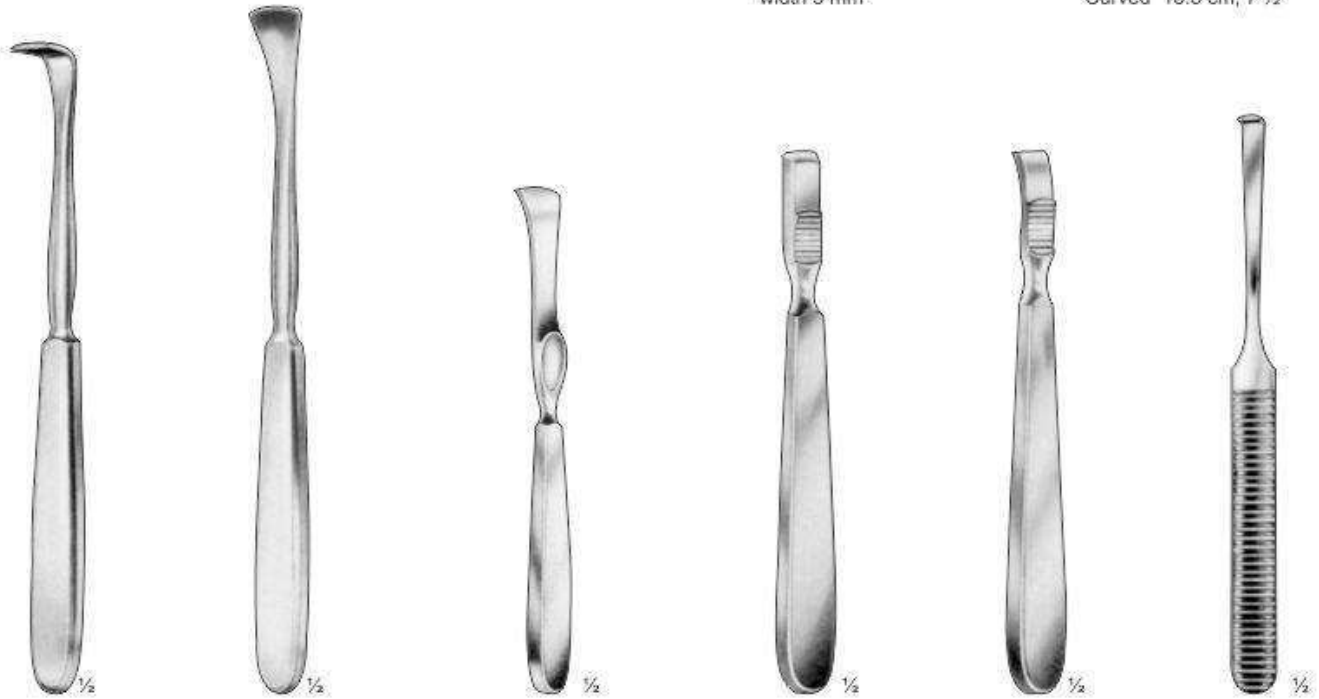

LANGENBECK
RIC-09-1530
18 cm, 7"

LANGENBECK
RIC-09-1540
19 cm, 7 1/2"

LAMBOTTE 21 cm, 8 1/2"
RIC-09-1550 1.0 cm
RIC-09-1551 1.5 cm
RIC-09-1552 2.0 cm

FARABEUF
RIC-09-1560
15 cm, 6"

FARABEUF
RIC-09-1570
15 cm, 6"

RIC-09-1580 5 mm
RIC-09-1581 6 mm
RIC-09-1582 7 mm
16 cm, 6 1/2"

DURA HOOKS / NERVE HOOKS



SCOVILLE
RIC-10-100
30 cm, 12"
Nerve Hook and
Dissector



SCOVILLE
RIC-10-110
30 cm, 12"
Nerve Hook and
Dissector



SCOVILLE
RIC-10-120
30 cm, 12"
Sympathectomy Hook
and Dissector



RIC-10-130
Davis



RIC-10-140
Sachs



RIC-10-150
Sachs



GRAHAM
RIC-10-160
16.5cm



SACHS
RIC-10-170
16.5cm

NERVE SEPARATOR & SPATULA



FRAZIER
RIC-10-180
12.5 cm, 5"



RIC-10-190
Small

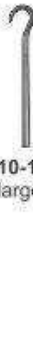

RIC-10-191
large



RIC-10-200
Straight
13 cm, 5"



LAHEY CLINIC
RIC-10-210
13 cm, 5"



SACHS
RIC-10-220
18.5 cm, 7 1/4"



RIC-10-230
16 cm, 6 1/2"



TOENNIS
RIC-10-240
15 cm, 6"



**DURA
TWIST HOOK**
RIC-10-250
14 cm, 5 1/2"

LAMINECTOMY RONGEURS

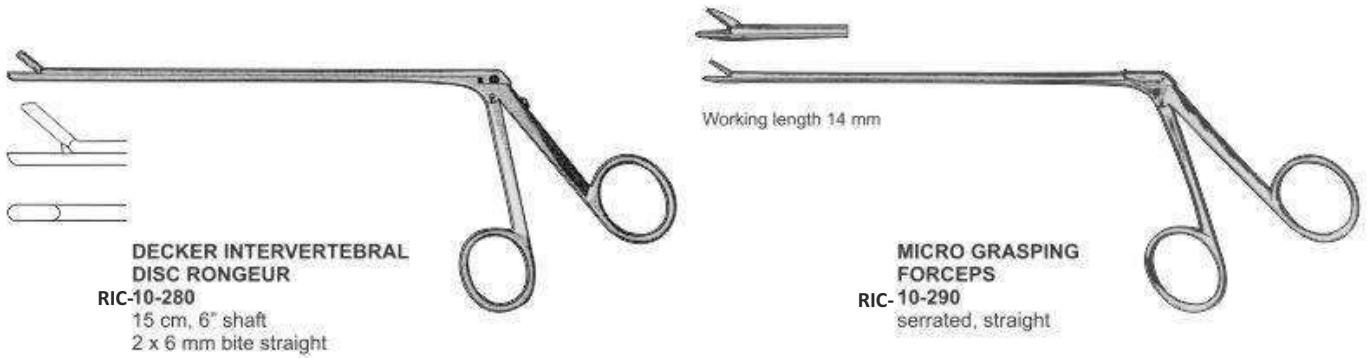
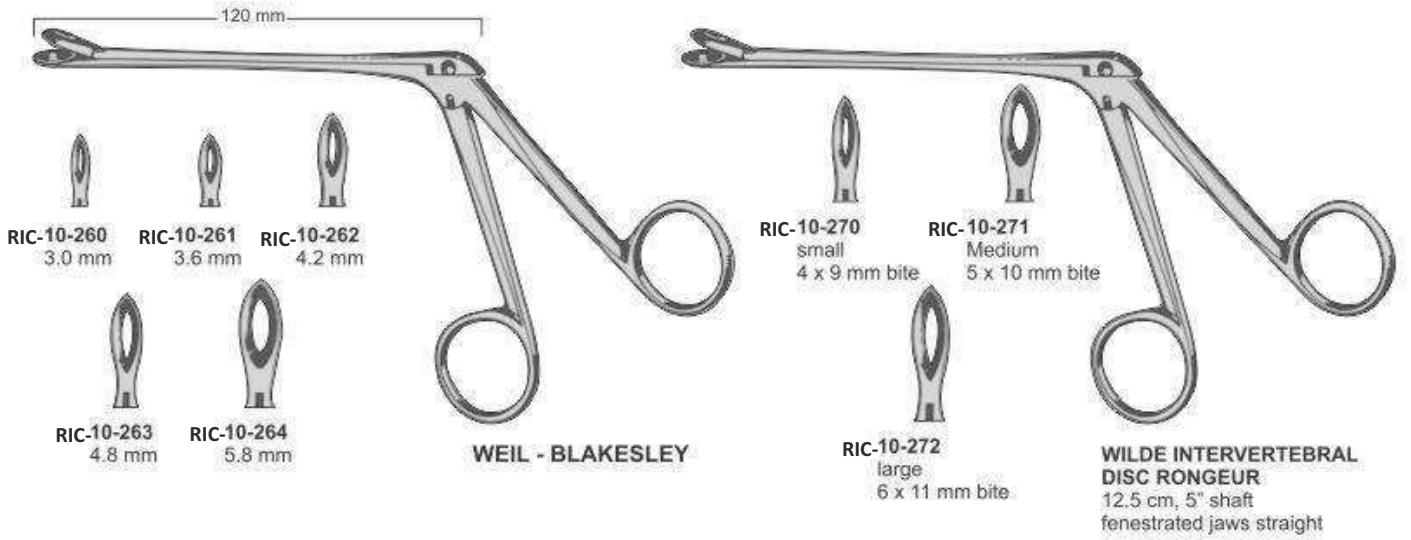

LAMINECTOMY RONGEURS



RIC-10-320
Grasping Forceps
ø 3 mm

RIC-10-321
Cup Forceps
ø 2 mm

RIC-10-322
Alligator Scissors
ø 2 mm

**MICRO ALLIGATOR
FORCEPS**
with tubular shaft
18 cm, 7"

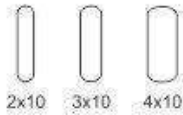

2x10 3x10 4x10

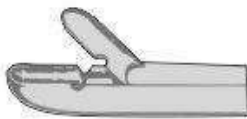

Straight Shaft	180 mm	
Bite 2 x 10 mm		RIC- 10-330
Bite 3 x 10 mm		RIC- 10-331
Bite 4 x 10 mm		RIC- 10-332



Angled - up Shaft	180 mm	
Bite 2 x 10 mm		RIC- 10-333
Bite 3 x 10 mm		RIC- 10-334
Bite 4 x 10 mm		RIC- 10-335

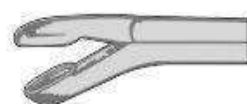

Angled - down Shaft	180 mm	
Bite 2 x 10 mm		RIC- 10-336
Bite 3 x 10 mm		RIC- 10-337
Bite 4 x 10 mm		RIC- 10-338

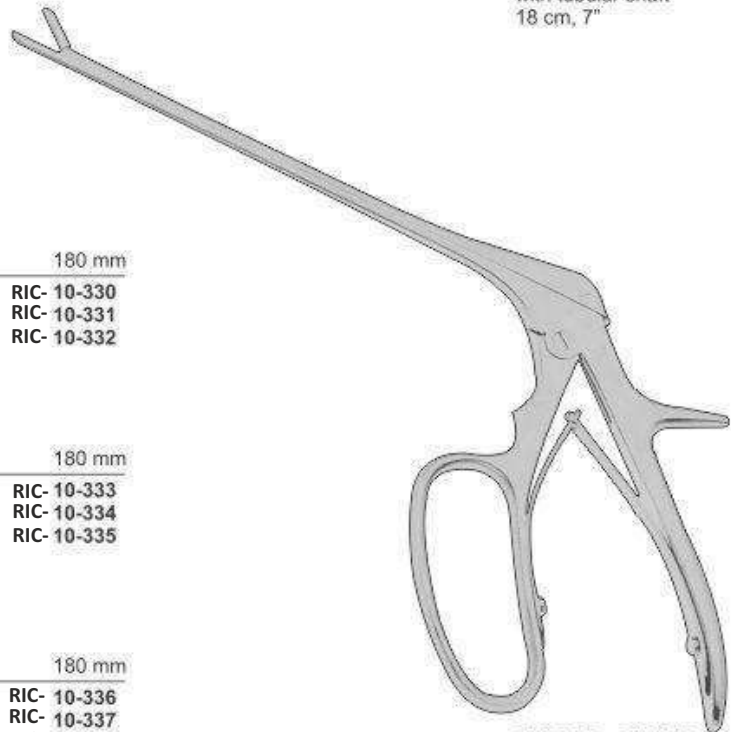

FERRIS - SMITH



4 mm 5 mm 6 mm

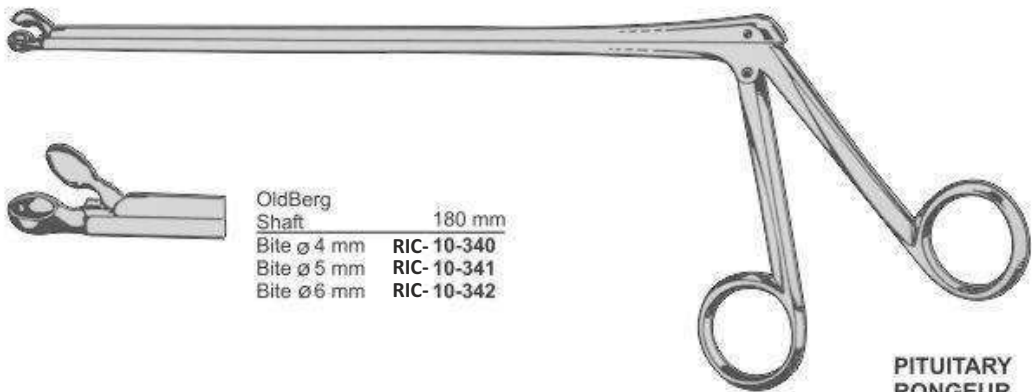

OldBerg Shaft	180 mm	
Bite ø 4 mm		RIC- 10-340
Bite ø 5 mm		RIC- 10-341
Bite ø 6 mm		RIC- 10-342

**PITUITARY
RONGEUR**



Kerrison Punch

45 Degree Down

- 1mm
RIC-KP-AD01 229mm

- 2mm
RIC- KP-AD02 229mm

- 3mm
RIC- KP-AD03 229mm

- 4mm
RIC- KP-AD04 229mm

- 5mm
RIC- KP-AD05 229mm



90 Degree upward

- 1mm
RIC-KP-U01 229mm

- 2mm
RIC- KP-U02 229mm

- 3mm
RIC- KP-U03 229mm

- 4mm
RIC- KP-U04 229mm

- 5mm
RIC- KP-U05 229mm



45 Degree upward

- 1mm
RIC-KP-AU01 229mm

- 2mm
RIC- KP-AU02 229mm

- 3mm
RIC- KP-AU03 229mm

- 4mm
RIC- KP-AU04 229mm

- 5mm
RIC- KP-AU05 229mm



90 Degree Down

- 1mm
RIC-KP-D01 229mm

- 2mm
RIC- KP-D02 229mm

- 3mm
RIC- KP-D03 229mm

- 4mm
RIC- KP-D04 229mm

- 5mm
RIC- KP-D05 229mm

DISC PUNCHES



CASPAR IVD RONGEURS FENESTRATED AND SERATTED JAWS LENGTH OF SHAFT 180 CM, 7"

2mm with teeth Straight - RIC.DP.TS2
 3mm with teeth Straight - RIC.DP.TS3
 4mm with teeth Straight - RIC.DP.TS4
 5mm with teeth Straight - RIC.DP.TS5

2mm with teeth Upward - RIC.DP.TU2
 3mm with teeth Upward - RIC.DP.TU3
 4mm with teeth Upward - RIC.DP.TU4
 5mm with teeth Upward - RIC.DP.TU5

2mm with teeth Down - RIC.DP.TD2
 3mm with teeth Down - RIC.DP.TD3
 4mm with teeth Down - RIC.DP.TD4
 5mm with teeth Down - RIC.DP.TD5

DISC RONGEURS OR DISC PUNCHES
CUSHING IVD RONGEURS LENGTH OF SHAFT 180 MM, 7"



- 2 x 10mm Straight - RIC.DP. ST2
- 2 x 10mm Upward - RIC.DP.U02
- 2 x 10 mm Down - RIC.DP.DN2

DISC RONGEUR OR DISC PUNCHES



LOVE-GRUENWALD IVD RONGEURS LENGTH OF SHAFT 180 MM, 7"

- | | |
|---------------------|-------------|
| 3 x 10 mm Straight | RIC-DP- SL3 |
| 3 x10 mm up angle | RIC-DP- UL3 |
| 3 x10 mm down angle | RIC-DP-DL3 |

DISC RONGEURS OR DISC PUNCHES
SPURLING IVD RONGEURS LENGTH OF SHAFT 180 MM, 7"



- | | |
|--------------------|--------------|
| 4 x 10 mm Straight | - RIC.DP.SPS |
| 4 x 10 mm Upward | - RIC.DP.SPU |
| 4 x 10 mm Down | - RIC.DP.SPD |

DISC RONGEUR OR DISC PUNCH



SCHLESINGER IVD RONGEUR SHAFT LENGTH 180 MM, 7" SERRATED
2 x 10 mm Straight RIC-DP-S2S
3 x 10 mm Straight RIC-DP-S3S
4 x 10 mm Straight RIC-DP-S4S

DISC- RONGER OR DISC-PUNCH



SCHLESINGER IVD RONGEUR 180 MM, 7" SERRATED JAWS

2 x 10 mm Upward RIC-DPS-SU2

3 x 10 mm Upward RIC-DPS-SU3

4 x 10 mm Upward RIC-DPS-SU4

SKIN GRAFTING HANDLES

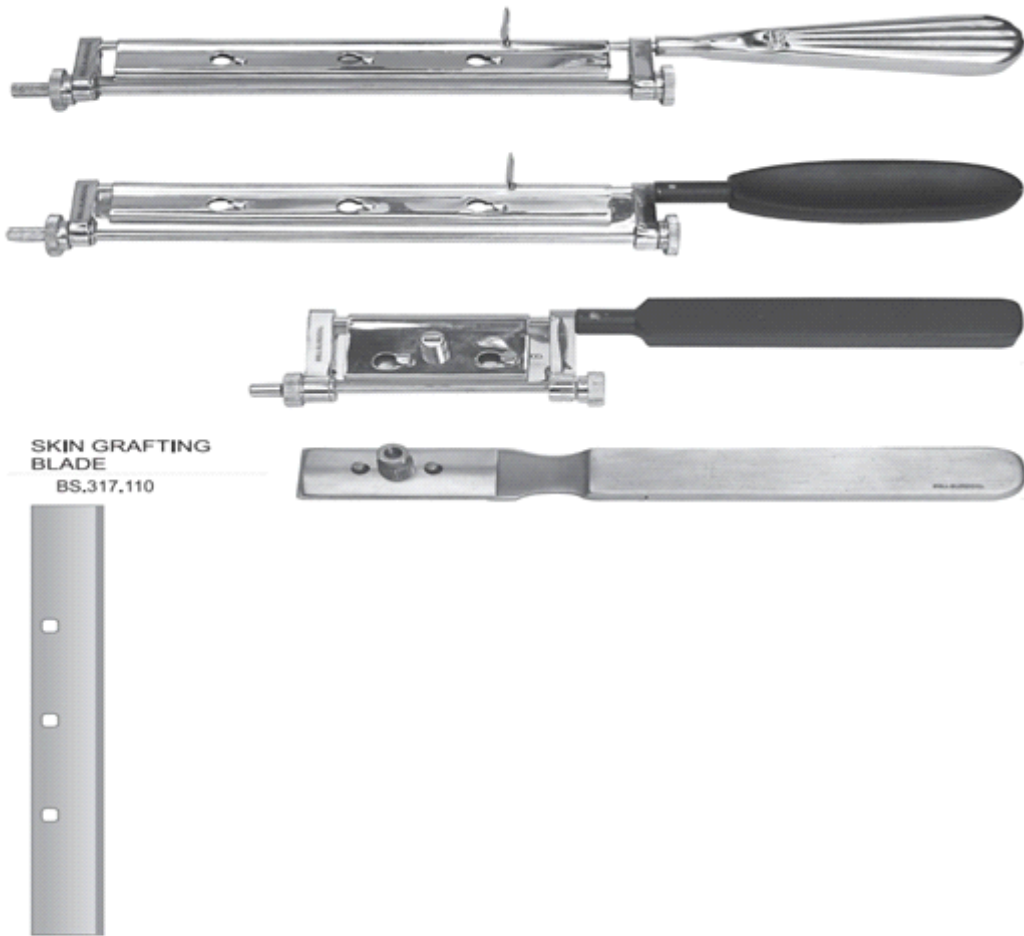

- | | |
|------------------------------|----------------|
| Skin Grafting Handle Humby's | - RIC-SKG- H12 |
| Skin Grafting Handle Watson | - RIC-SKG-W12 |
| Skin Grafting Handle Silver | - RIC-SKG-SL6 |
| Skin Grafting Handle Simple | - RIC-SKG-NL6 |
| Skin Grafting Blade | - RIC-SKB-110 |

RELIANCE INSTRUMENTS
CORPORATION



**ORTHOPEDIC
INSTRUMENTS**

TABLE OF CONTENTS

S.No		Page No
1	ORTHOPEDIC DRESS- PLASTER INSTRUMENTS	61 - 62
2	AMPUTATION SAW – GIGLI SAW	63 - 64
3	REAMERS-BONE AWLS-BONE HOOKS	65 - 66
4	ORTHOPEDIC HAND BONE DRILLS	67 - 68
5	BONE HOLDING CLAMPS- TRACTION BAR	69 - 70
6	WISE GRIPS – NOSE PLIERS – SLAP HAMMERS	71 - 72
7	NOSE PLIERS – PULLING FORCEPS – WIRE CUTTERS	73 - 75
8	PLIERS –BENDERS – ROD INSTRUMENTS	76
9	WIRE INSTRUMENTS – EXTENSION BOWS	77 - 78
10	RING CUTTERS-LEAD HANDS- BIOPSY TOOLS	79 - 80
11	BONE TAMPERS –IMPACTORS- PACKERS	81
12	BONE RASPS – FILES	82 - 84
13	BONE LEVERS – RETRACTORS	85 - 91
14	CHISELS – OSTEOTOMES –GOUGES	92 - 97
15	BONE CURETTES	98 - 103
16	PERIOSTEAL ELEVATOR – DISSECTORS	104 - 106
17	PERIOSTEAL ELEVATORS – RESPIRATORY	107
18	PERIOSTEAL ELEVATORS – DISSECTORS	108
19	ELEVATORS SPINAL- S/S & FIBRE & MALLET	109
20	ORTHOPEDIC MALLETS- S/S & Fiber	110

TABLE OF CONTENTS

S.No		Page No
21	ELEVATORS SPINAL – S/S & FIBRE	111 - 112
22	MENISCUS – TENDON – CARTILAGE INSTRUMENTS	113 - 115
23	PELVIC REDUCTION FORCEPS	116 - 117
24	BONE HOLDING FORCEPS	118 - 124
25	REPOSITION ,CARTILAGE- FORCEPS	125 - 126
26	BONE CUTTING FORCEPS	127 - 130
27	BONE RONGEURS – NIBBLERS	131 - 139
28	LAMINA, CALCANEAL ,FEMORAL TIBIAL – SPREADER	140 - 141
29	CARBIDE INSERTED SURGICAL SCISSORS	142 - 143
30	INSTRUMENTS FOR TRUMATOLOGY	144 - 155
31	PARALLEL PLIER WITH K WIRE CUTTER (T.C TYPE)	156
32	PARALLEL PLIER WITH K WIRE CUTTER (REGULAR)	157 - 158
33	LATEST BONE LEVER	159

ORTHOPEDIC DRESSING – PLASTER INSTRUMENTS

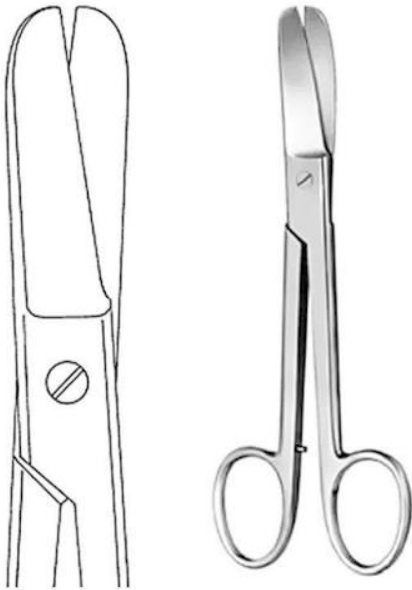

RIC-01-0300

Lorenz Bandage Scissors
Heavy Pattern 23 cm / 9"

Also available
in 18.5 cm / 7 1/4"
& 20 cm / 8"

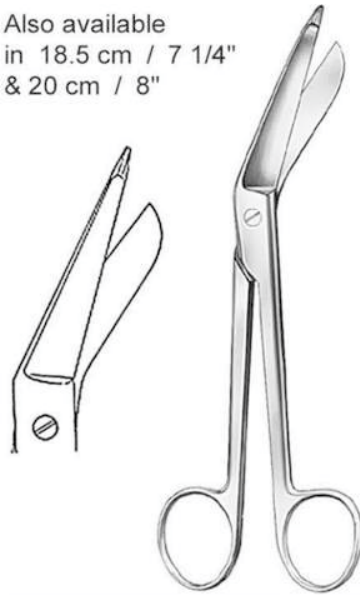

RIC-01-0301

Lister Bandage Scissors
14.5 cm / 5 3/4"

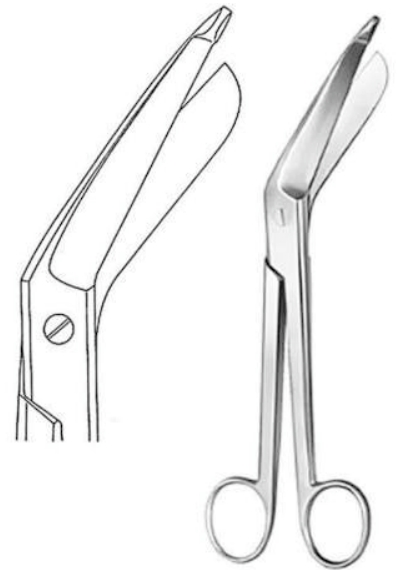

RIC-01-0302

Bergmann Plaster Shears
Heavy Pattern 23.5 cm / 9"



RIC-01-0303

Esmarch Plaster Shears
Heavy Pattern, Short Blades
20 cm / 8"



Also available
in 18cm / 7 1/2"

RIC-01-0304

Bandage Scissors
16cm / 6 1/4" Black Plastic Rings

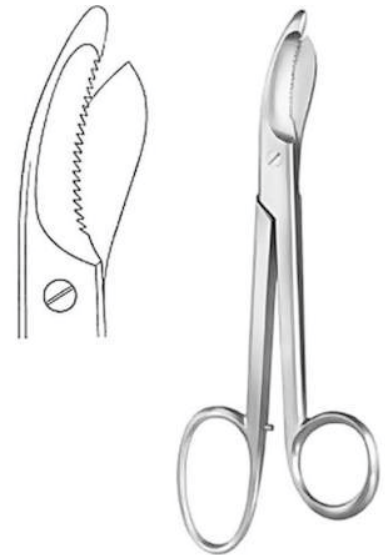

RIC-01-0305

Bruns Plaster Scissors 24 cm
9 1/2" One Serrated Cutting Edge

ORTHOPEDIC DRESSING – PLASTER INSTRUMENTS

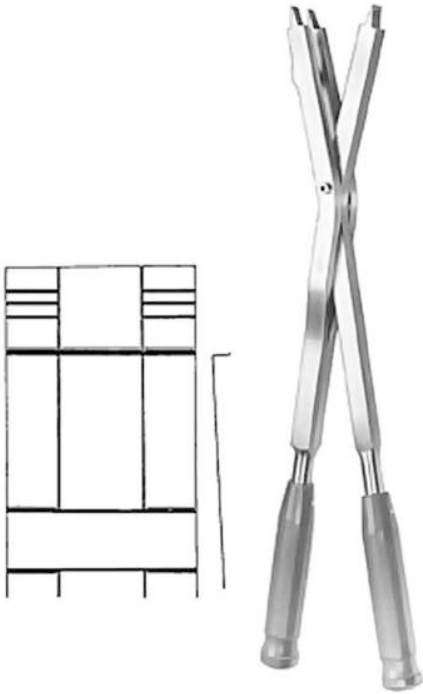

RIC-01-0313

Hermann Plaster Spreader
48 cm / 19" Heavy Pattern

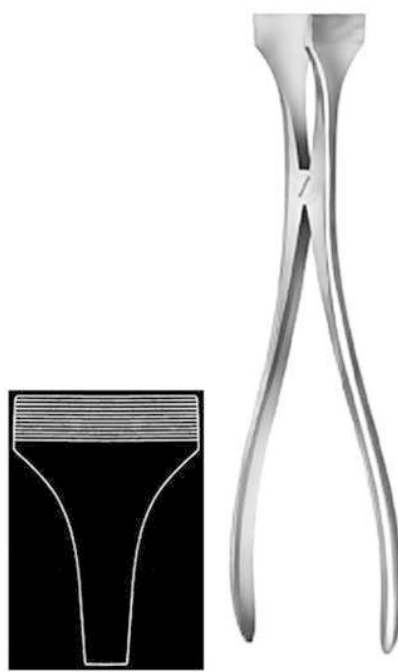

RIC-01-0314

Hennig Plaster Spreader
28 cm / 11"



RIC-01-0315

Hennig Plaster Spreader
30 cm / 12"



RIC-01-0316 Beeson Plaster Spreader 1.5 in Blade 30 cm / 12"



RIC-01-0317 Walton Plaster Spreader w/Spring 3 Prongs 23 cm / 9"

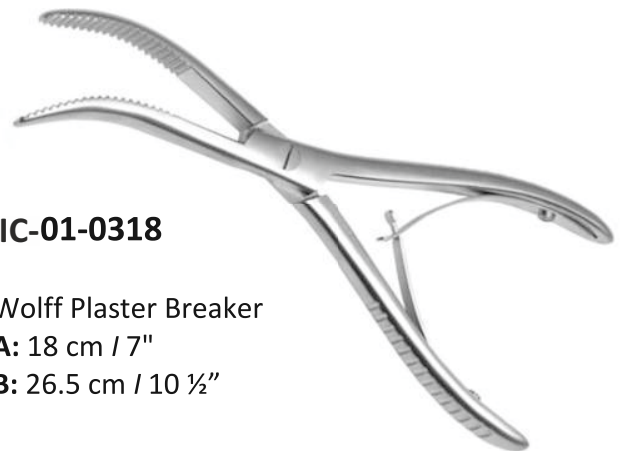

RIC-01-0318

Wolff Plaster Breaker
A: 18 cm / 7"
B: 26.5 cm / 10 ½"

AMPUTATION SAW – GIGLI SAW

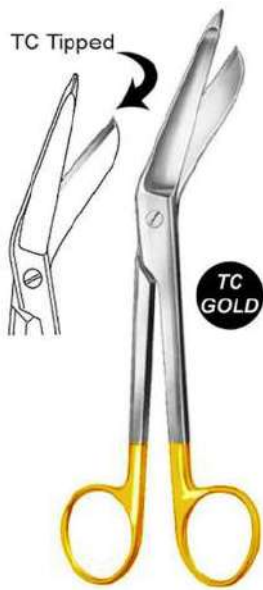

RIC-01-0319
Lister Bandage Scissors TC
18 cm / 7" cm / 13 3/4"



RIC-01-0320
Bruns Plaster Scissors
24 cm / 9 1/2"



RIC-01-0321
Charriere Amputation Saw 35 cm / 13 3/4"



A: 21.5 cm / 8 3/4" 12mm



B: 21.5 cm / 8 3/4" 15mm



C: 21.5 cm / 8 3/4" 18mm

Spare Saw Blades



RIC-01-0322
BIER Amputation Saw 40.5 cm / 16"



A: 27 cm / 10 3/4" 4 mm wide



B: 27 cm / 10 3/4" 6 mm wide



C: 27 cm / 10 3/4" 8 mm wide



RIC-01-0323
Langenbeck Amputation Saw 24.5 cm / 9 3/4"



RIC-01-0324 Satterlee Amputation Saw
29 cm / 11 1/2"



RIC-01-0325 Charriere Amputation Saw 27 cm / 10 1/2"



RIC-01-0326 Satterlee Amputation Saw 23 cm / 9"

AMPUTATION SAW – GIGLI SAW

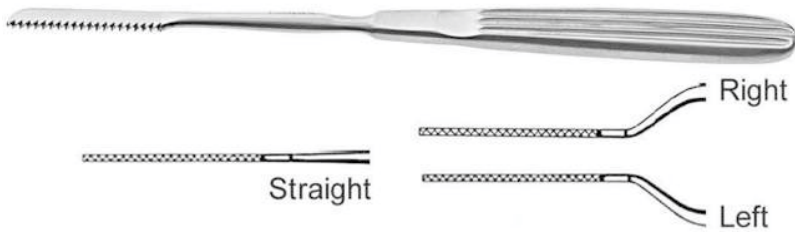

RIC-01-0327 Joseph Amputation Saw 18 cm / 7"

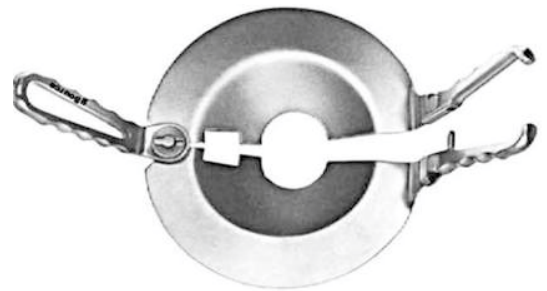

RIC-01-0328

Percy Amputation Shield 30 cm / 12"



RIC-01-000

- A:** Gigli Saw 30cm
- B:** Gigli Saw 50cm
- C:** Tyler Gigli Saw (Large Cut) 30cm
- D:** Tyler Gigli Saw (Large Cut) 30cm

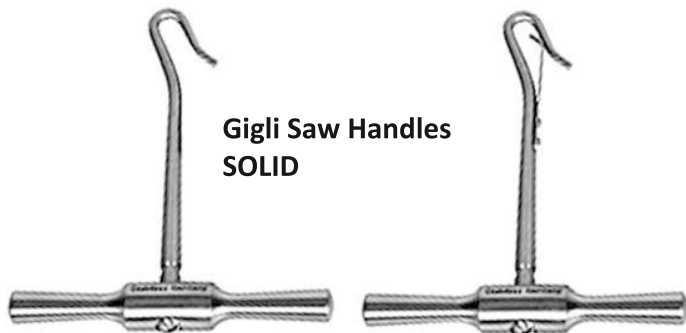

Gigli Saw Handles SOLID

RIC-01-001 Gigli Sold in Pair

RIC-01-002 Gigli Sold in Pair



RIC-01-005 BAILEY GIGLI SAW GUIDE 30 CM



RIC-01-006 POPPEN GIGLI SAW GUIDE 28 CM



Gigli Saw Handles SOLID

RIC-01-003 Gigli Sold in Pair

RIC-01-004 Gigli Sold in Pair



REAMERS - AWLS - BONE HOOKS



RIC-01-0329

Reamer
13.5cm / 5 1/4"



RIC-01-0330

Perthes Reamer
18 cm / 7"



RIC-01-0331

Perthes Reamer
21.5 cm / 8 1/2"



RIC-01-0332

Reamer One concave
side 14 cm / 5 1/2"

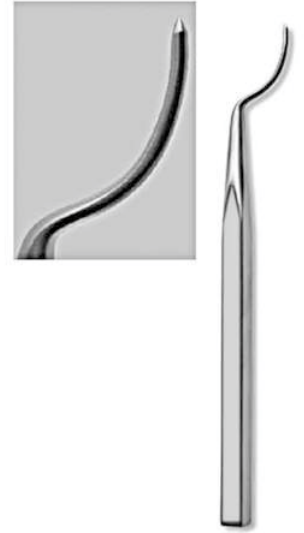

RIC-01-0333

Glenoid Punch
20 cm / 8"

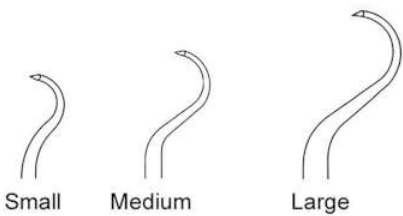

RIC-01-0334

Shoulder Percussion Awl **A:** 21 .5cm / 8 1/2" **B:** 23.5cm / 9 1/4"



A: 20cm / 8"
19X27mm
Sharp

B: 23cm / 9"
15X20mm
Blunt

C: 23cm / 9"
15X20mm
Sharp

C: 25cm / 9 3/4"
15X20mm
Sharp

RIC-01-0335 Volkman Bone Hook

REAMERS - AWLS – BONE HOOKS



Pointed

RIC-01-0336

Kuntscher Diamond Awl 28 cm / 11"

Pointed

RIC-01-0337

Rush Awl / Reamer

A: 19 cm / 7 1/2" 2.5mm

B: 21 cm / 8 1/4" 3mm

C: 21 cm / 8 1/2" 5mm

D: 26 cm / 10 1/2" 6mm

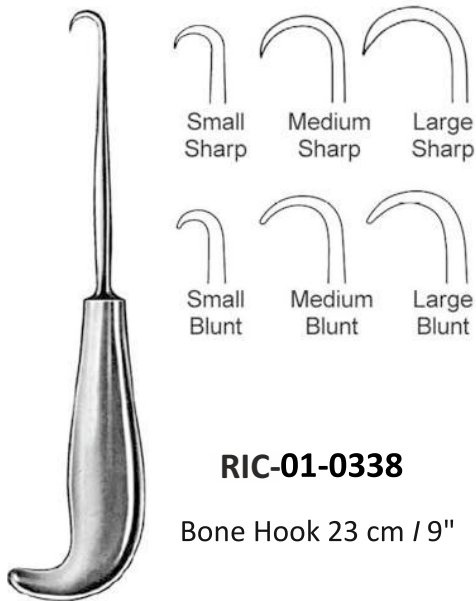

Small Sharp

Medium Sharp

Large Sharp

Small Blunt

Medium Blunt

Large Blunt

RIC-01-0338

Bone Hook 23 cm / 9"

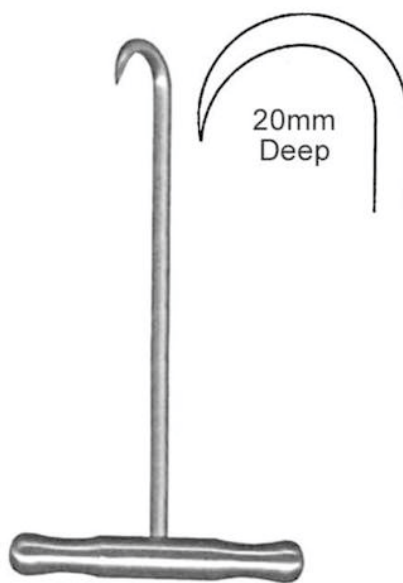

20mm Deep

RIC-01-0339

Bone Hook T Handle 20 cm / 8"



20mm Deep

RIC-01-0340

Bone Hook T Fiber Handle 14cm / 5 5/8"

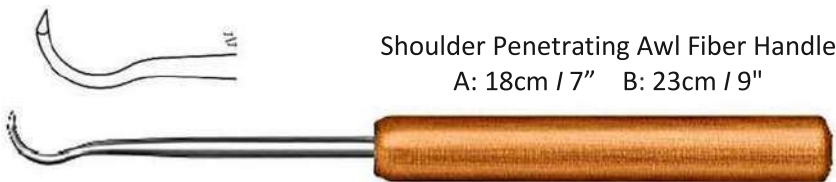

Shoulder Penetrating Awl Fiber Handle

A: 18cm / 7" **B:** 23cm / 9"

RIC-01-0341



RIC-01-0342

Pointed Awl Fiber Handle 25cm / 10"

ORTHOPEDIC HAND BONE DRILLS -ACC



RIC-01-0348
Bunnell Hand Drill
16cm / 6-1/4"

Longitudinally Bored with 3-Jaw-Chuek
Light Metal Housing opening up to 4mm



RIC-01-0349
Bunnell Hand Drill
16cm / 6-1/4"

Twin Shade Powder Coated Longitudinally
bored with 3-Jaw-Chuek light metal
housing opening up to 4mm



RIC-01-0350
Ralk Hand Drill

Light Metal Housing
Literally Angled Handle with 3-Jaw-Chuek
and key, opening up to 6,35mm

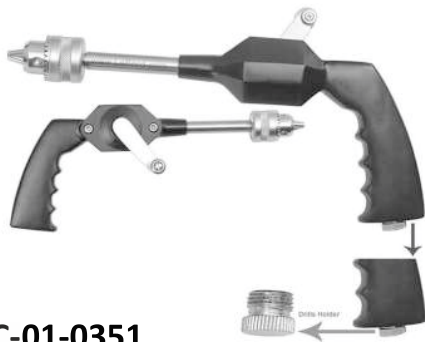

RIC-01-0351

HAND DRILL
All Covered Polished / Dull or Coated.
Drills Holder at Bottom.

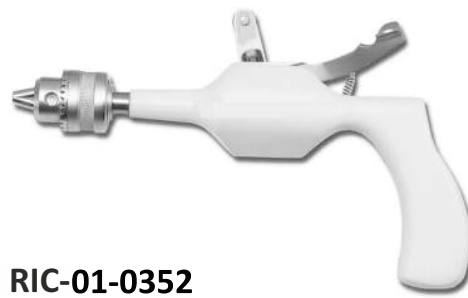

RIC-01-0352

Hand Drill
All Covered Light Weight / Polished /
Dull or Coated. Key Holder and Self
Retaining Locking Mechanism



Box for Hand Drills
Outside Artificial Leather
/ inside Jumbo Foam



RIC-01-0353

Hand Drill
Polished / Dull or Coated. Operated
Horizontally and Vertically



RIC-01-0354

Hand Drill
Polished / Dull or Coated.
All Covered

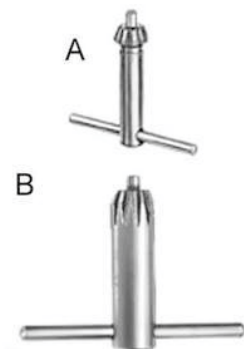

All Hand Drills
Provided with Keys

ORTHOPEDIC HAND BONE DRILLS -ACC



RIC-01-0355

Hand Drill
Polished / Dull
Or Coated.
Open Housing



RIC-01-0356

Hand Drill
Polished / Dull
Or Coated.
Open Housing



RIC-01-0357

Hand Drill
Polished / Dull
Or Coated.
Semi Closed Housing



RIC-01-0358

Vickers Easidriver 14 Cm / 5 1/2"



RIC-01-0359

14 cm / 5 1/2"
Handle W/ Chuck Longitudinally
Bored Accommodating up to 3,95mm



RIC-01-0360

Handle with chuck T-Shaped



RIC-01-0361

Fiber T-Handle Key



RIC-01-0362

Key



RIC-01-0363

Key

BONE HOLDING CLAMPS – TRACTION BAR



RIC-01-0364 Gerster-Lowman Bone Holding Clamp

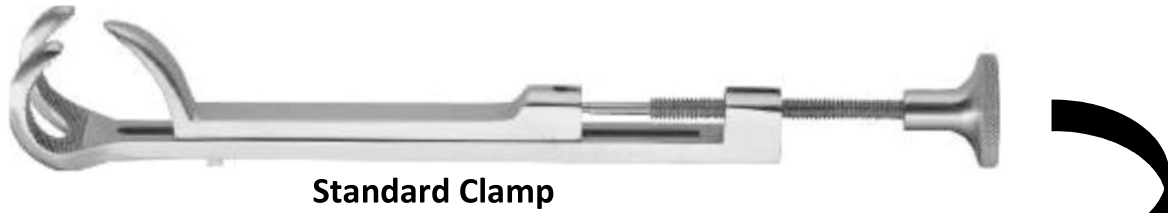

Standard Clamp

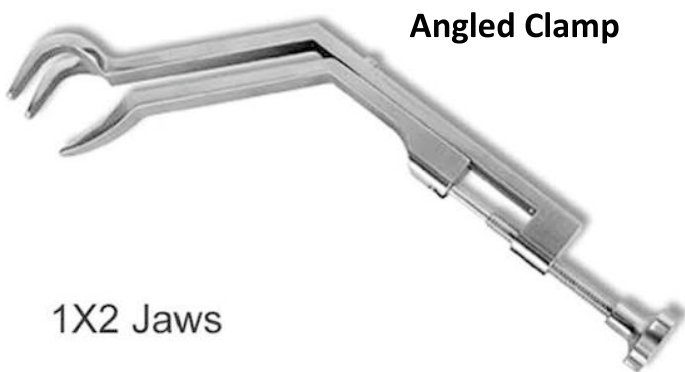
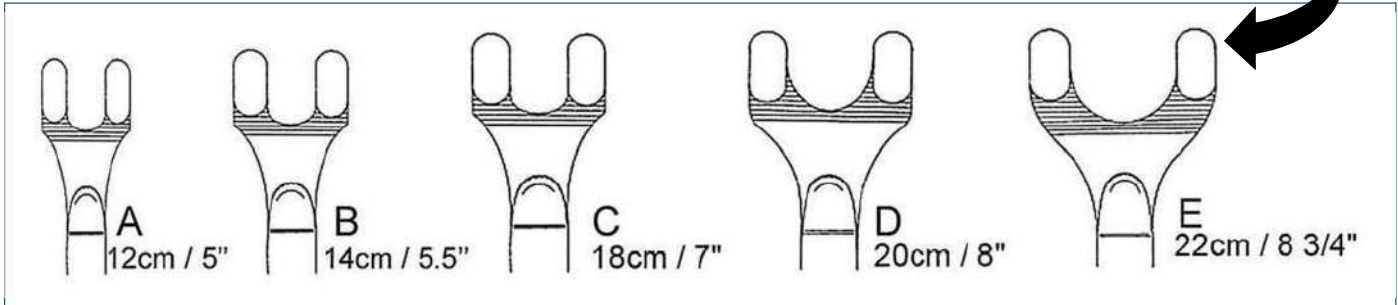

Angled Clamp

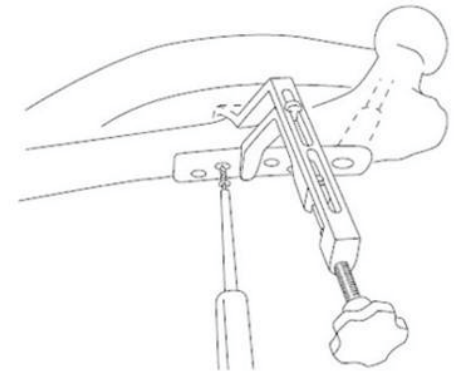

RIC-01-0365 Gerster-Lowman Bone Holding Clamp

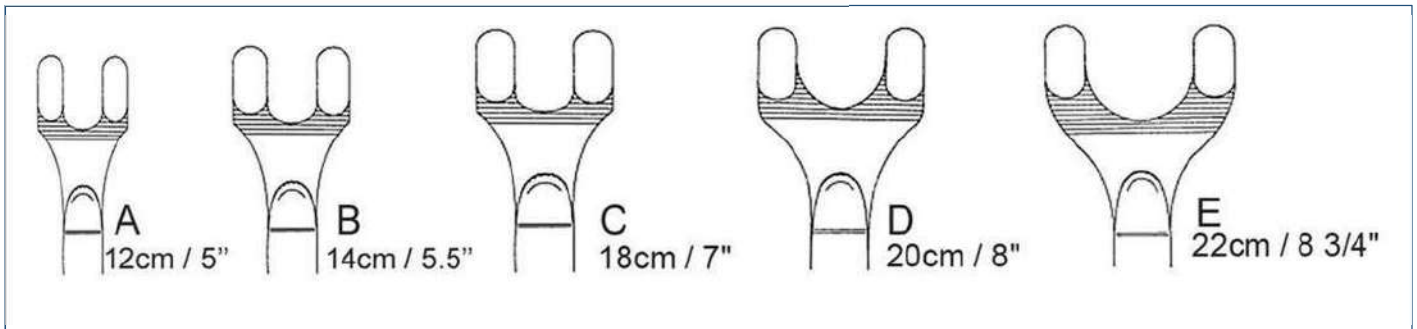

BONE HOLDING CLAMPS – TRACTION BAR



RIC-01-0366 Gerster Traction bar 15 cm / 6"

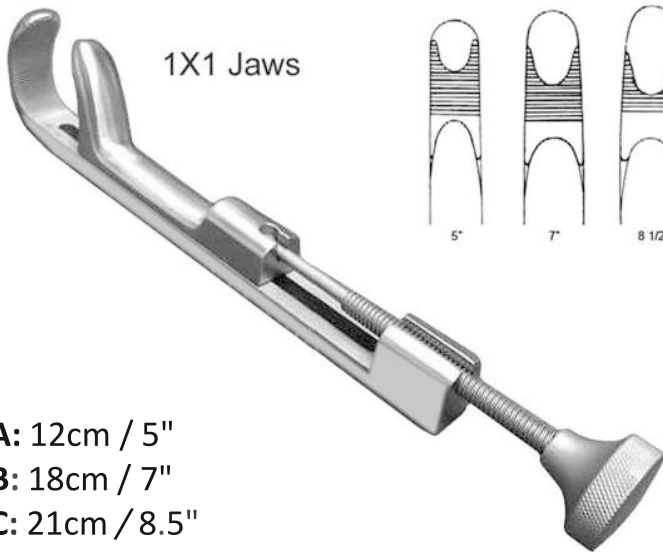

1X1 Jaws

- A: 12cm / 5"
- B: 18cm / 7"
- C: 21cm / 8.5"

RIC-01-0367
Gerster-Lowman Bone Holding Clamp

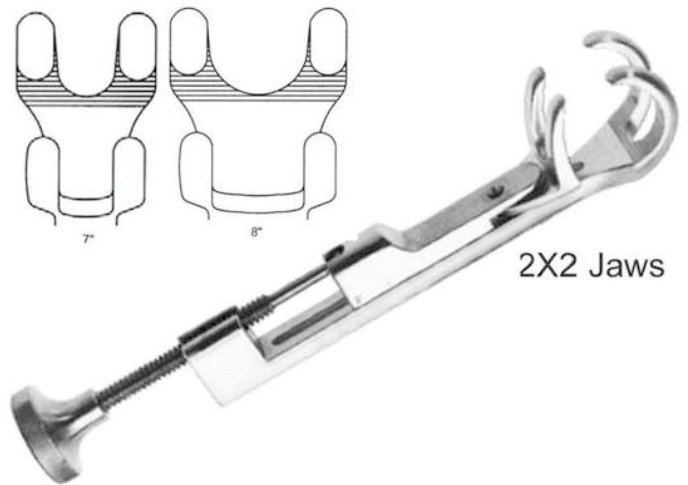

2X2 Jaws

- A: 18cm / 7"
- B: 20cm / 8"

RIC-01-0368
Gerster-Lowman Bone Holding Clamp

WISE GRIPS – NOSE PLIERS – SLAP HAMMERS [ALL MADE OF STAINLESS STEEL]



RIC-01-0369

Vise Grip Locking Plier 23 cm / 9"



RIC-01-0372

Needle Nose Locking Plier 30 cm / 12"



RIC-01-0370

Vise Grip Locking Plier 20.5 cm / 8"



RIC-01-0373

Needle Nose Locking Plier 25.5 cm / 10"



RIC-01-0371

Vise Grip Locking Plier 18 cm / 7"



RIC-01-0374

Needle Nose Locking Plier 22 cm / 8.5"

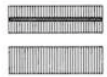

RIC-01-0375

Flat Nose Plier 18.5 cm / 7 ¼" Parallel Grip SS



Max 1.6mm Cutting Capacity

RIC-01-0376

Flat Nose Plier-Cutter 18.5 cm / 7 ¼" Parallel Grip SS



RIC-01-0377

Long Nose Plier 22 cm / 8 ¼"



RIC-01-0378

Vise Grip 20.5 cm / 8" Stainless Steel

VICE GRIPS – NOSE PLIERS – SLAP HAMMERS [ALL MADE OF STAINLESS STEEL]



RIC-01-0379

Regular Jaw Locking Plier

A: 18 cm / 7" B: 20 cm / 8" C: 23 cm / 9"



RIC-01-0380

Needle Nose Locking Plier

A: 22 cm / 8.5" B: 25.5 cm / 10" C: 30 cm / 12"



RIC-01-0381

SLAP HAMMER w/ Threaded Shaft Head



RIC-01-0382

SLAP HAMMER w/ Hexa Shaft Head



RIC-01-0383

Combi-Fiat Nose Pliers 15 cm / 6"

For Bending & Cutting



RIC-01-0385

Flat Nose Plier 13.5 cm / 5 ¼"



RIC-01-0384

Round / Flat Nose Pliers 18 cm / 7"



RIC-01-0386

Hackstock Flat Nose Pliers 16 cm / 6 ¼"

with longitudinal groove

NOSE PLIERS – PULLING FORCEPS – WIRE CUTTERS

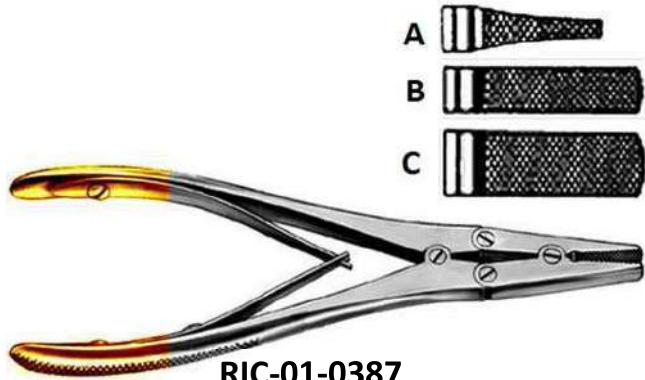

RIC-01-0387
Flat Nose Pliers 18 cm / 7" Parallel Grip



RIC-01-0388
Flat Nose Pliers 17 cm / 6 ¾" with crosswise groove



RIC-01-0389
Flat Nose Pliers 17.5 cm / 7"



RIC-01-0390
Flat Nose Pliers Pointed 19.5 cm / 7 ¾"



RIC-01-0391
Platypus Nail Pulling Forceps 15.5 cm / 6 ¼"

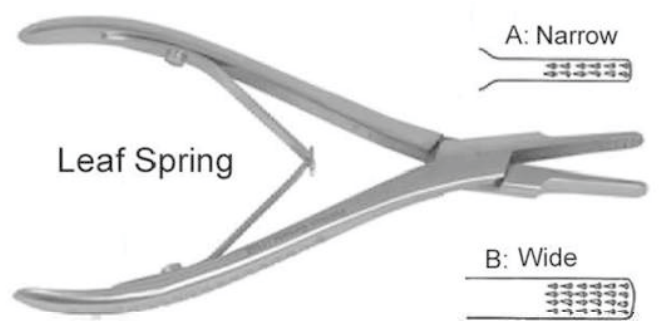

RIC-01-0392
Platypus Nail Pulling Forceps 15.5 cm / 6 ¼"



RIC-01-0393
Round Nose Pliers 15.5 cm / 6 ¼"

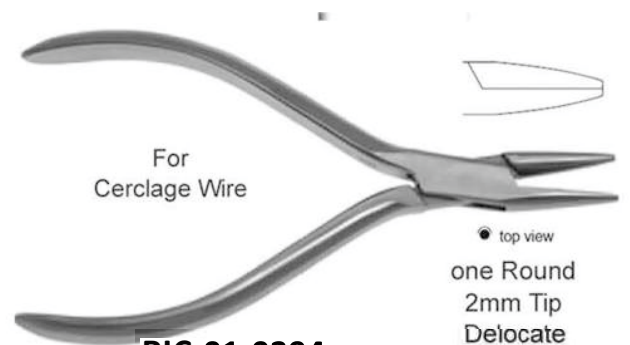

RIC-01-0394
Needle Nose Pliers 15.5 cm / 6 ¼"

NOSE PLIERS – PULLING FORCEPS – WIRE CUTTERS

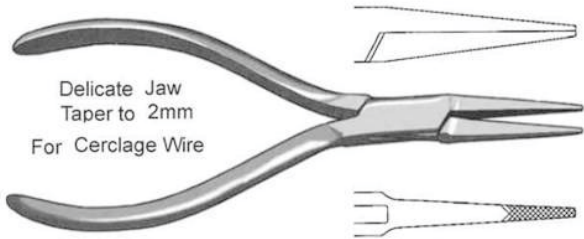

RIC-01-0395

Flat Nose Pliers 15 cm / 6"

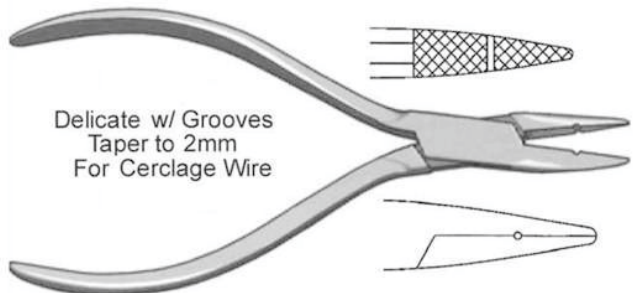

RIC-01-0396

Needle Nose Pliers 13.5 cm / 5 1/4"

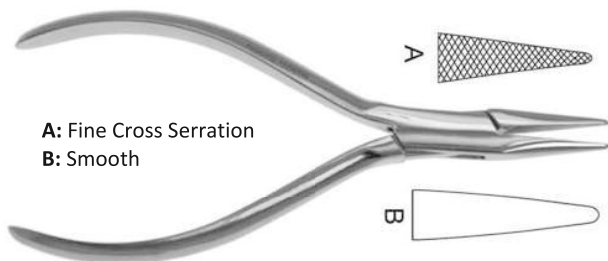

RIC-01-0397

Needle Nose Pliers Taper to 2mm Tip 14 cm / 5 1/2"



RIC-01-0398

Wire Cutting Pliers 18.5 cm / 7 1/4"



RIC-01-0399

Martin "Diamant" 16cm / 6 1/4"

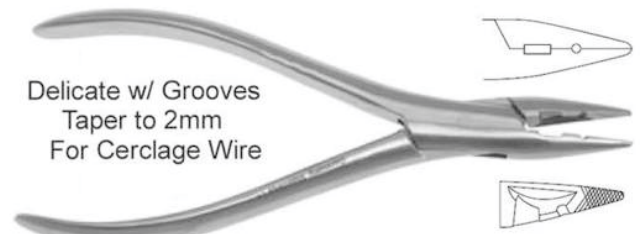

RIC-01-0400

Circlage Pliers / Cutter 14 cm / 5 1/2"

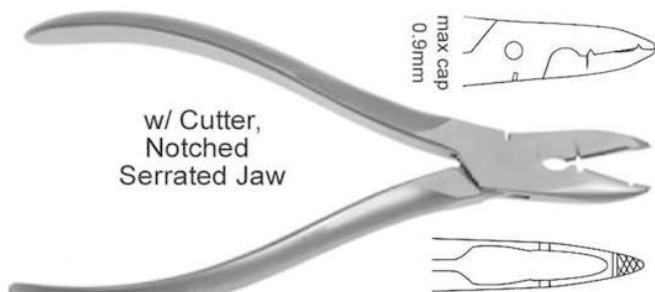

RIC-01-0401

Wire Bending Pliers 20 cm / 8"

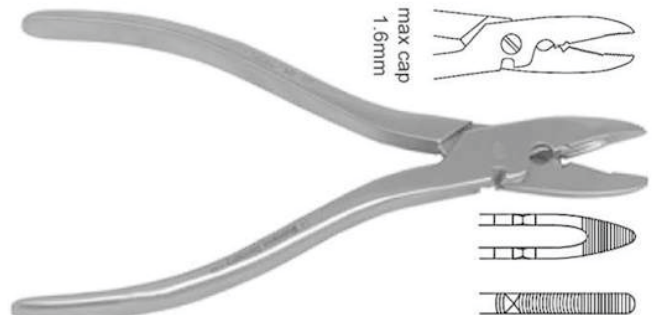

RIC-01-0402

Wire Bending Pliers 15 cm / 6"

NOSE PLIERS – PULLING FORCEPS – WIRE CUTTERS



RIC-01-0403
Wire Bending Pliers TC 20 cm / 8"

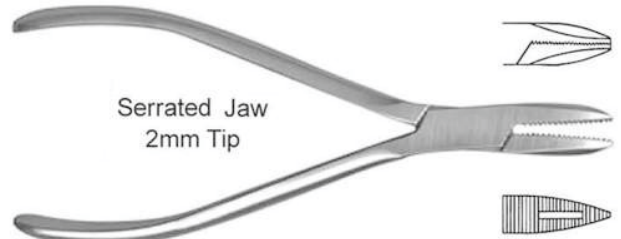

RIC-01-0404
Needle Nose Pliers 15 cm / 6"

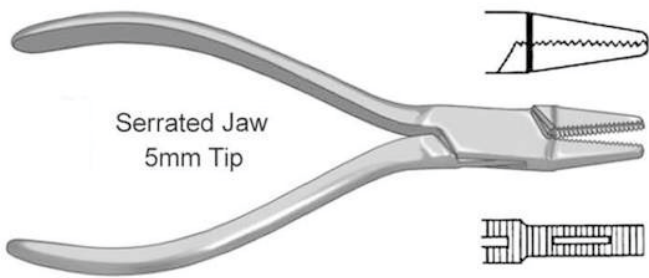

RIC-01-0405
Flat Nose Pliers 14 cm / 5 1/2"

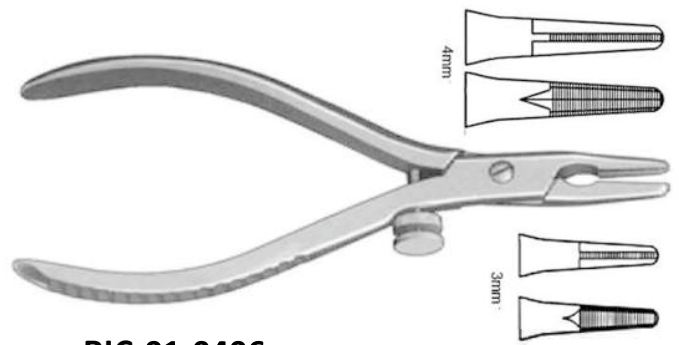

RIC-01-0406
K-Wire Pliers **A:** 13 cm / 5" **B:** 17.5 cm / 7"



RIC-01-0407
Screw/Pin Removing Pliers 19 cm / 7 1/2"

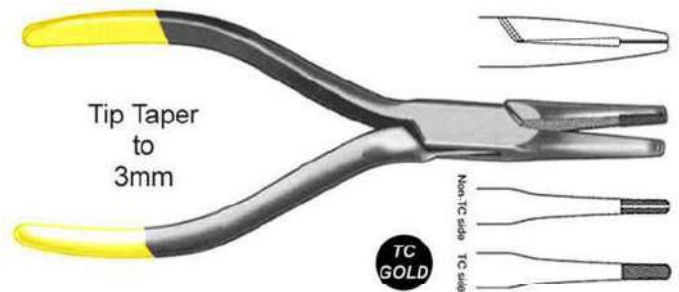

RIC-01-0408
Pin Puller Grips Small Pins 14 cm / 5 1/2"



RIC-01-0409
Flat Nose Pliers w/ Cutter for Cerclage Wire 16 cm / 6 1/2"

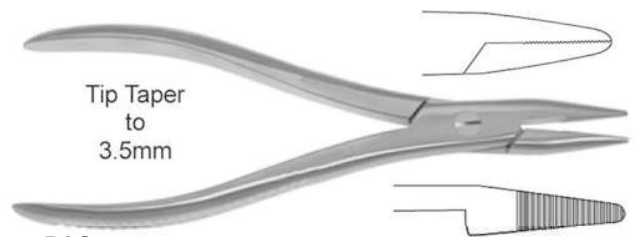

RIC-01-0410
19 cm / 7 1/2" Narrow Nose Pliers Heavy Jaws for Pulling Wire / Pins

PLIERS – BENDERS – ROD INSTRUMENTS

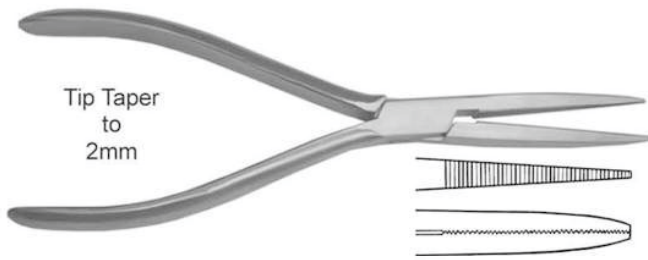

Tip Taper to 2mm

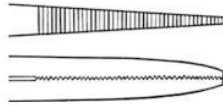

RIC-01-0411

Long Jaw Pliers 2inch Long Jaw Delicate 17.5 cm / 7"

- A: 17.5 cm / 7" Needle Nose 2" Jaw
- B: 16 cm / 6 1/2" Square 7mm Jaw
- C: 18 cm / 7" Tape to 2mm Tip

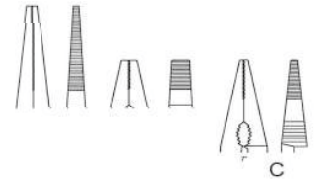

RIC-01-0412

UNIVERSAL Pliers
Serrated w/ Heavy duty Spring and Cutting Edge
Max Cutting Cap: 1.1 mm

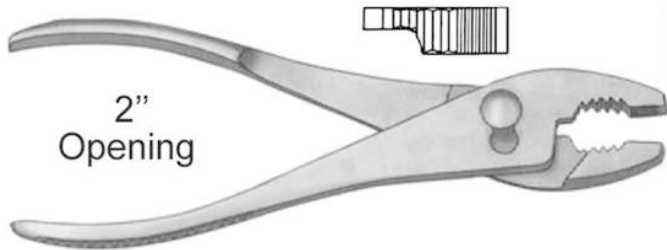

2" Opening



RIC-01-0413

Slip Joint Pliers 20 cm / 8"

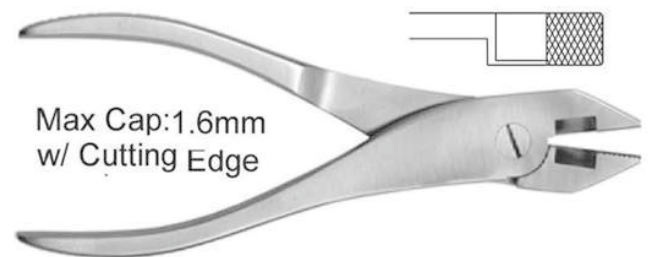

Max Cap: 1.6mm w/ Cutting Edge

RIC-01-0414

Lineman Pliers 21 cm / 8 1/2"

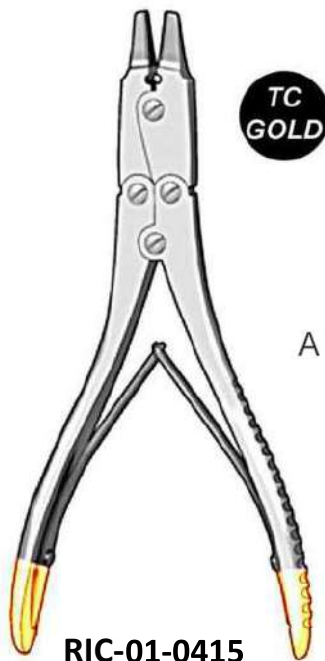

TC GOLD

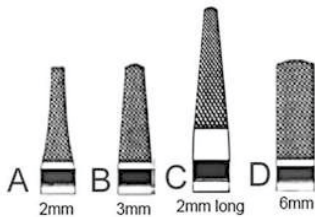

- A: 2mm Delicate Jaw TC
- B: 3mm Jaw TC
- C: 2mm Long Jaw TC
- D: 6mm Jaw TC

RIC-01-0415

Double Action Wire Extraction Plier
18 cm / 7"

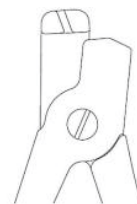
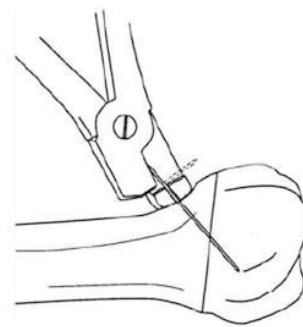

RIC-01-0416

Gratloch Wire Bender
19 cm / 7 1/2"

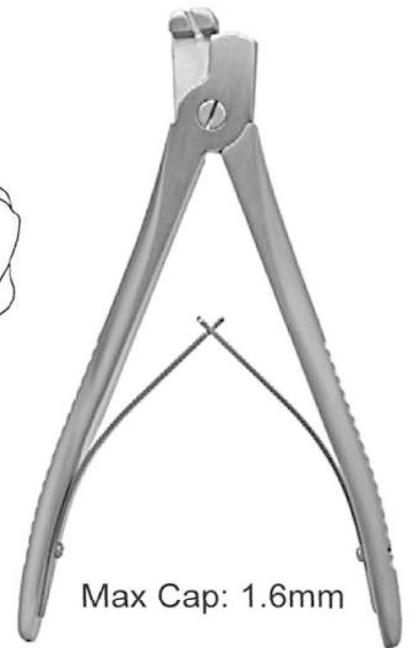

Max Cap: 1.6mm

WIRE INSTRUMENTS – EXTENSION BOWS

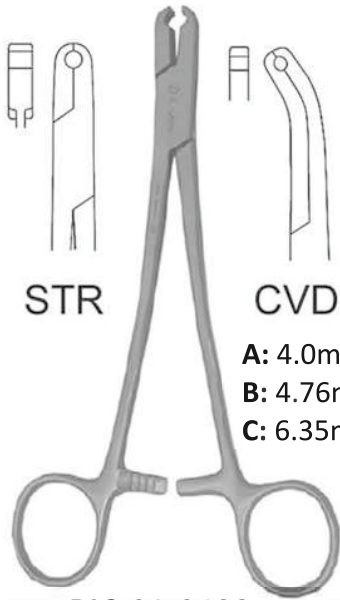

STR

CVD

- A: 4.0mm Rod
- B: 4.76mm Rod
- C: 6.35mm Rod

RIC-01-0423

Rod Holder 18 cm / 7 ¼"



RIC-01-0424

Wire Pulling Forceps 16 cm / 6 ½"

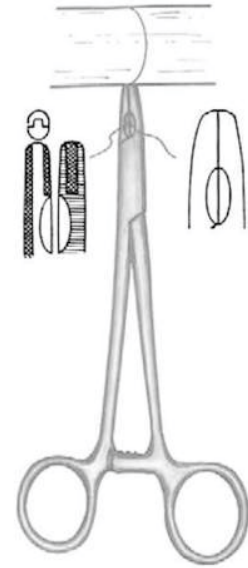

RIC-01-0425

Wire Twister / Tightner 16cm / 6 ¼"



RIC-01-0426

Loute Wire Tightener 21 cm / 8 ¼"

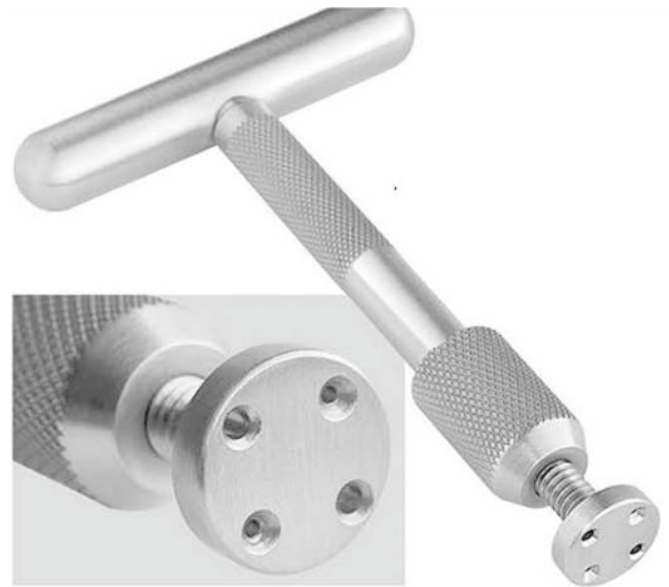

RIC-01-0428

Wire Tightener w / T Handle
11.5 cm / 4 ½"



RIC-01-0427

Wire Tightener 12 cm / 4 ¾"

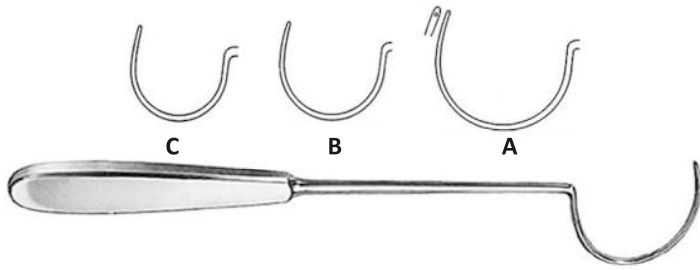

A: 31 cm / 12 ¼"
 B: 29 cm / 11 ½"
 C: 28 cm / 11"

RIC-01-0429
 Demel Wire Guide



CVD Crochet Hook
 18cm / 7 1/4"

RIC-01-0430
 Bankert Ligature Carrier

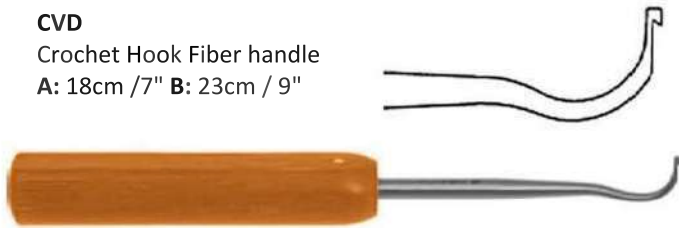

CVD
 Crochet Hook Fiber handle
 A: 18cm / 7" B: 23cm / 9"

RIC-01-0431
 Suture Passer

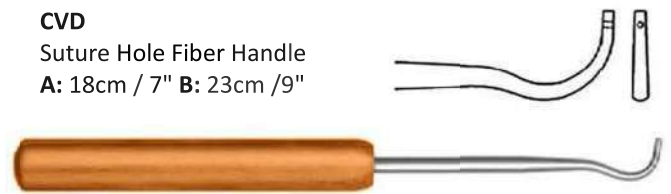

CVD
 Suture Hole Fiber Handle
 A: 18cm / 7" B: 23cm / 9"

RIC-01-0432
 Suture Passer



Suture Hole
 20cm / 8"
 A: Right Blunt
 B: Left Blunt
 C: Right Sharp
 D: Left Sharp

RIC-01-0433
 Deschamps Ligature Carrier

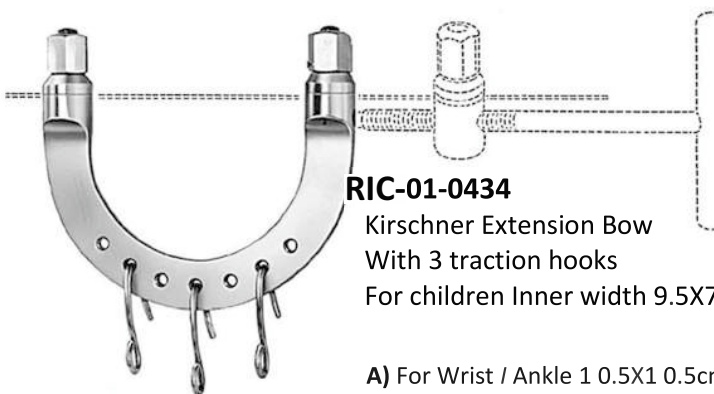

RIC-01-0434
 Kirschner Extension Bow
 With 3 traction hooks
 For children Inner width 9.5X7cm

A) For Wrist / Ankle 1 0.5X1 0.5cm
 B) For Elbow 12X12cm
 C) For Knee 15.5X15.5cm
 D) For Femur 20X15.5cm

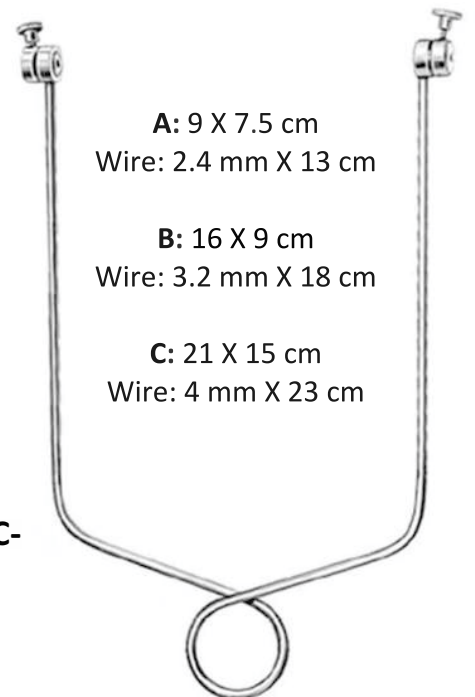

RIC-

A: 9 X 7.5 cm
 Wire: 2.4 mm X 13 cm
 B: 16 X 9 cm
 Wire: 3.2 mm X 18 cm
 C: 21 X 15 cm
 Wire: 4 mm X 23 cm

RIC-01-0435
 Bohler Extension Bow for femur & knee

RING CUTTERS – LEAD HANDS – BIOPSY TOOLS



Complete with Drills
(Set of 3 drills) Small / Medium / Large

RIC-01-0442
Martin-Ideal
Finger Nail Drill



RIC-01-0443
Feldheim Tourniquet 10 cm / 4"

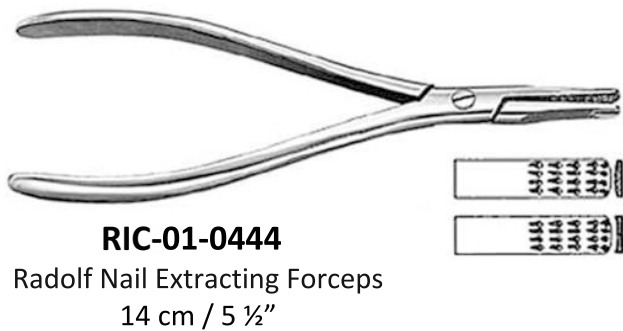

RIC-01-0444
Radolf Nail Extracting Forceps
14 cm / 5 1/2"

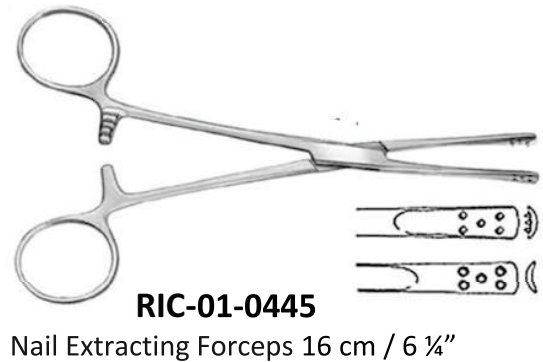

RIC-01-0445
Nail Extracting Forceps 16 cm / 6 1/4"



RIC-01-0446
Martin Finger Ring Saw 18.5 cm / 6 3/4"
Spare Blades are Available Separately



RIC-01-0447
Walton Finger Ring Saw 16cm / 6 1/4"
Spare Blades are Available Separately



RIC-01-0448
Finger Ring Saw 17cm / 6 3/4"
Spare Blades are Available Separately



RIC-01-0449
Finger Ring Saw Cutter Spare

Stainless Steel
Black Color

Stainless Steel
Color

RING CUTTERS – LEAD HANDS – BIOPSY TOOLS



RIC-01-0450

Lead Hand for Kids / Adults

RIC-01-0451

Lead Hand for Kids / Adults

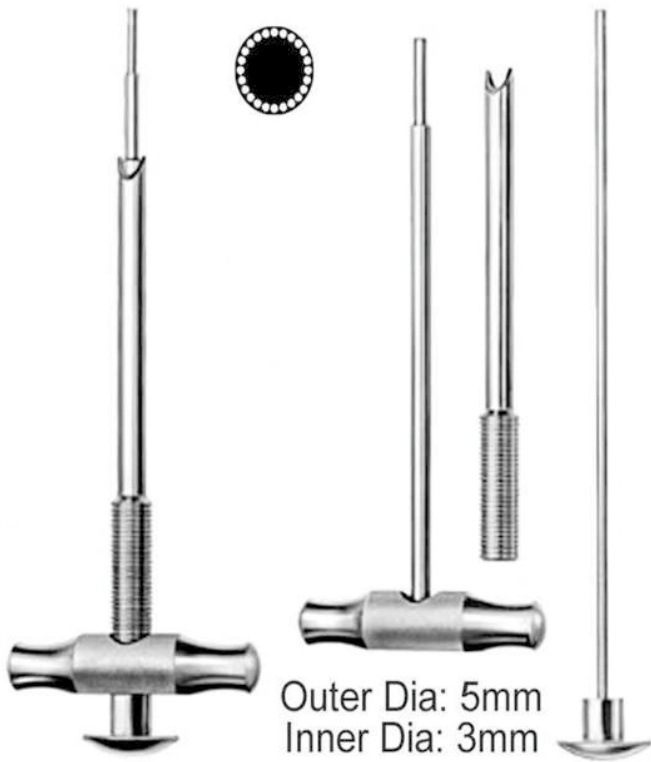

RIC-01-0452

Champy-OSU Bone Biopsy Instruments

22 cm / 8 3/4"

Consisting of trocar, a toothed trephine and a plunger for taking tibial and iliac bone grafts through a closed technique

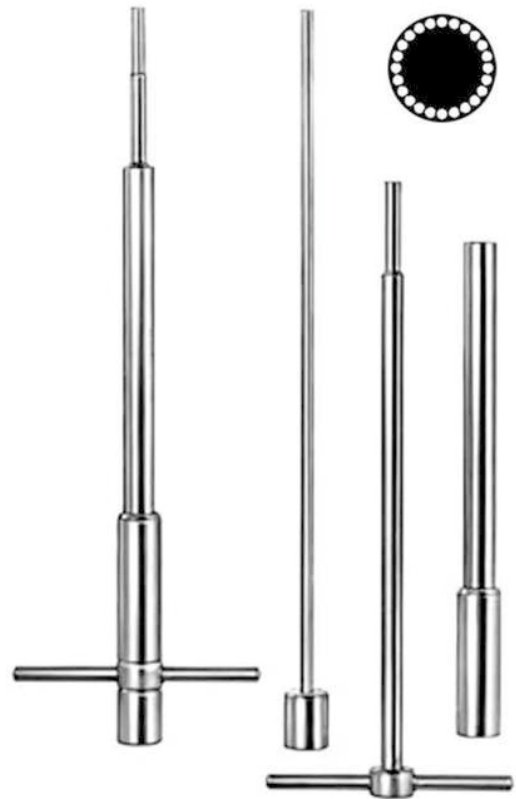

RIC-01-0453

Champy Bone Biopsy Instruments

22 cm / 8 3/4"

- A) Outer Dia: 5mm / Inner Dia: 4mm
- B) Outer Dia: 8mm / Inner Dia: 7mm

BONE TAMPERS – IMPACTORS - PACKERS



RIC-01-0454

Bone Tamper
15.5 cm / 6" Tip
Sizes: 2-3-4-5-6-8-9-10 mm



A: 2 mm **B:** 3 mm **C:** 4 mm **D:** 5 mm
E: 6 mm **F:** 8 mm **G:** 9 mm **H:** 10 mm



RIC-01-0455

Champy Cancellous Bone graft Mill

Outer Dia: 17mm
Inner Dia: 16mm

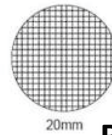

RIC-01-0456

Bone Impactor / Teflon Tip 17cm / 6 1/2"



RIC-01-0457

Caspar Bone Tamper 20 cm / 8"



RIC-01-0458

Lumbar / Cervical Impactor 21cm / 8 1/2"

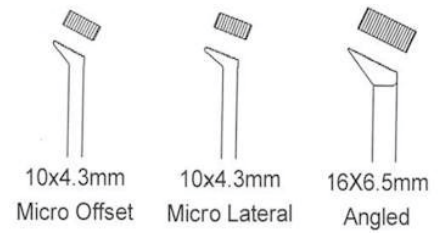

RIC-01-0459

Lumbar / Cervical Impactor 21cm / 8 1/2"

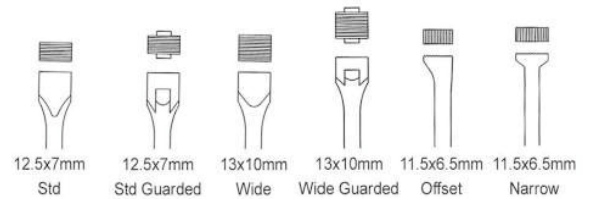

BONE RASPS - FILES



RIC-01-0471A

Bone File 18 cm / 7" Fiber Handle / STR Diamond Coated



RIC-01-0471B

Bone File 18 cm / 7" Fiber Handle / CVD Diamond Coated

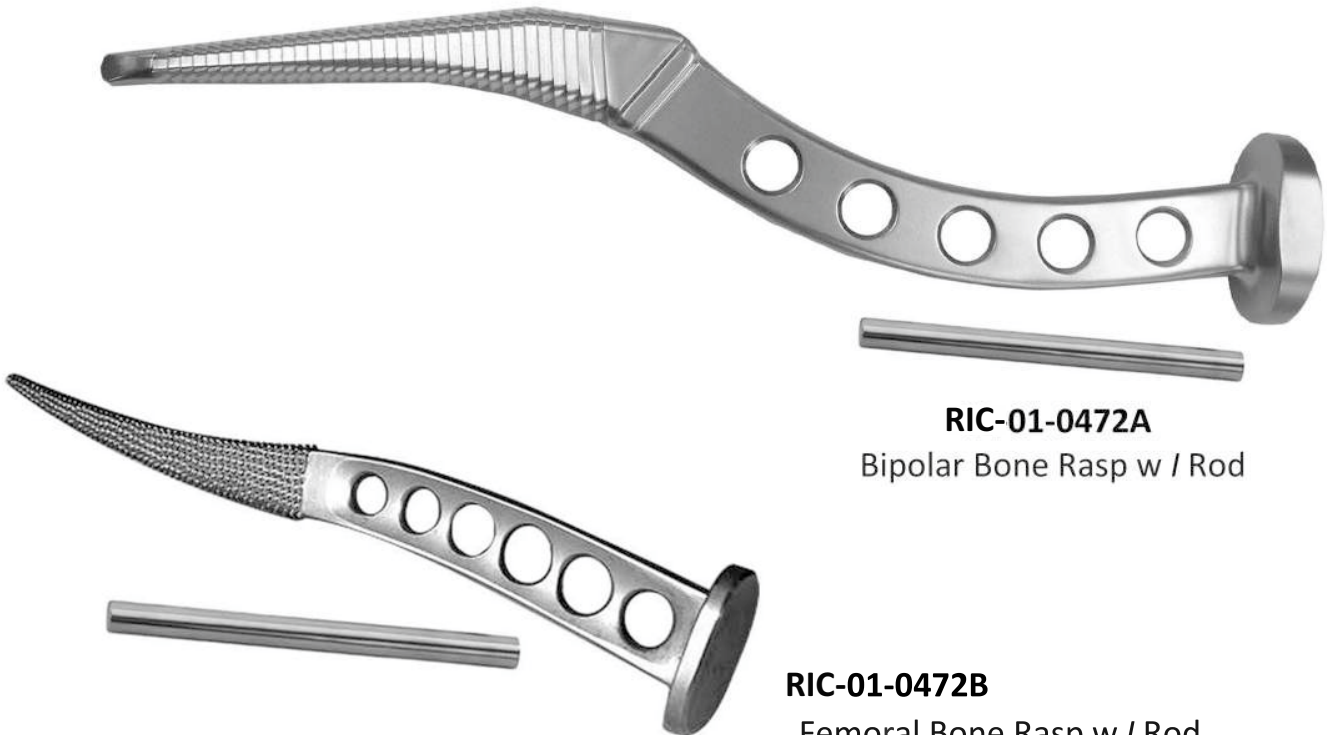

RIC-01-0472A

Bipolar Bone Rasp w / Rod

RIC-01-0472B

Femoral Bone Rasp w / Rod

A: Small B: Medium C: Large

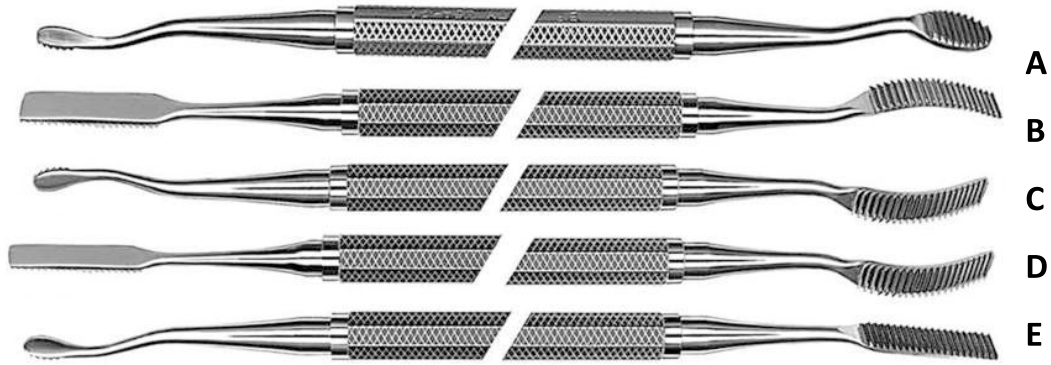

RIC-01-0473

Miller-Colburn Bone File 18 cm / 7" Downwards Cut

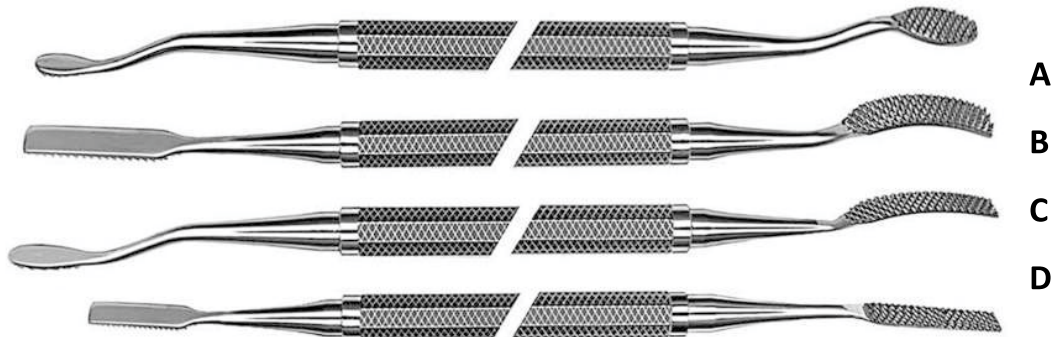

RIC-01-0474

Miller-Colburn Bone File 18 cm / 7" Cross Cut

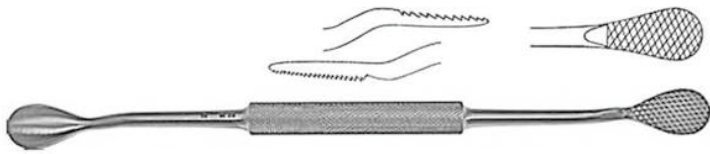

RIC-01-0475

Bone Rasp 21 cm / 8.5" 13mm Fine/Coarse Straight

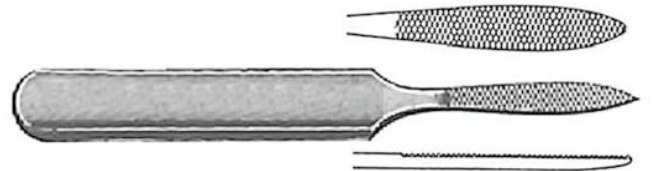

RIC-01-0476

Bone Rasp Joseph 16 cm / 6.25" 8mm Fine Cross Serrated / Straight

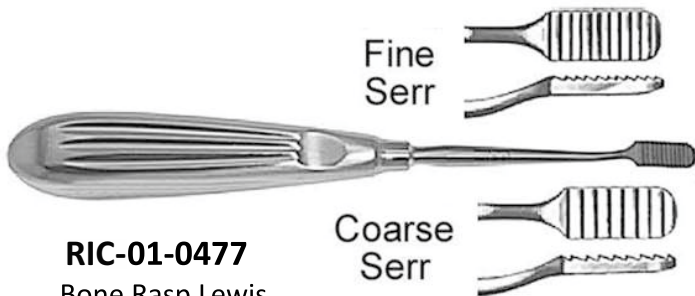

RIC-01-0477

Bone Rasp Lewis 19 cm / 7.5" 8mm

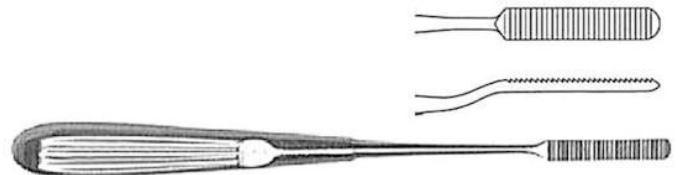

RIC-01-0478

Bone Rasp Cottle 20 cm / 8" 7mm Plain Serrated Downward

BONE RASPS - FILES

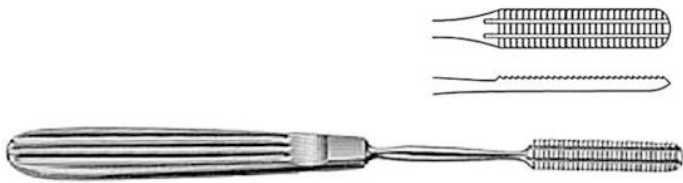

RIC-01-0479

Bone Rasp Maltz 18 cm / 7"
9mm Plain Coarse Serr Downward



RIC-01-0480

Bone Rasp Aufriecht 18 cm / 7"
9mm Coarse Serr CVD

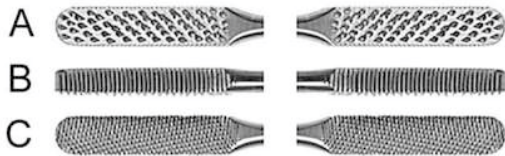

RIC-01-0481

Bone Rasp Fomon 21 cm / 8.5"
8mmX40mm Course Serr 4 Sided Flat / Convex Baldes

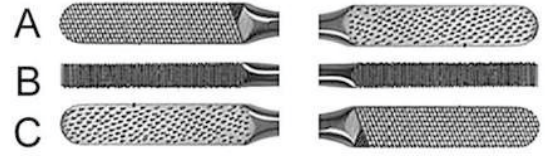

RIC-01-0482

Bone Rasp Fomon 21 cm / 8.5"
8mmX40mm Fine Serr 4 Sided Flat / Convex Blades



RIC-01-0483

Bone Rasp Kleinert Kurtz 21 cm / 8.5"
8mmX45mm Fine/Coarse Serr 4 Sided Flat / Convex

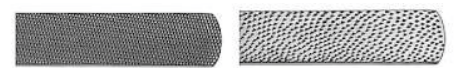

RIC-01-0484

Bone File / Rasp 21 cm / 8.5"
18mm Fine / Coarse Serr

BONE LEVERS - RETRACTORS



RIC-01-0485
Bone Lever 16 cm / 6 ¼"

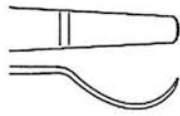

RIC-01-0486
Hohman, Mini Bone Lever 16 cm / 6 ¼" 6 mm tip



RIC-01-0487
Hohman, Mini Bone Lever 16 cm / 6 ¼" 8 mm tip



RIC-01-0488
Mini Bone Lever 16cm / 6 ¼" 14 mm tip

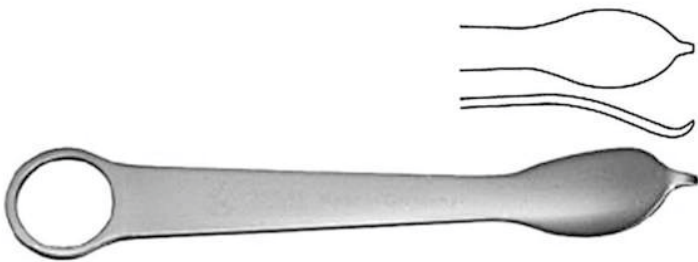
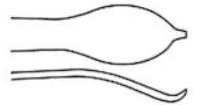

RIC-01-0489
Hohman, Mini Bone Lever 12 cm / 4 ¾" 14 mm tip

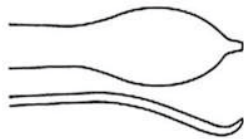

RIC-01-0490
Hohmann Bone Lever 22 cm / 8 ¾" 8 mm Tip narrow tip

RIC-01-0490



RIC-01-0491
Hohmann Bone Lever 23.5 cm / 9 ¼" 18 mm Tip narrow tip

RIC-01-0491



RIC-01-0492
Hohmann Bone Lever 23.5 cm / 9 ¼" 43 mm Tip narrow tip

RIC-01-0492



RIC-01-0493
Hohmann Bone Lever 29 cm / 11 ½" 35mm Tip wide tip

RIC-01-0493



RIC-01-0494
Lange-Hohmann Bone Lever 25 cm / 9 ¾" 22mm Tip
Wide tip with groove

RIC-01-0494

BONE LEVERS - RETRACTORS

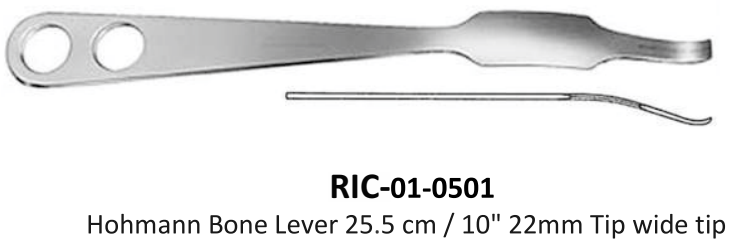
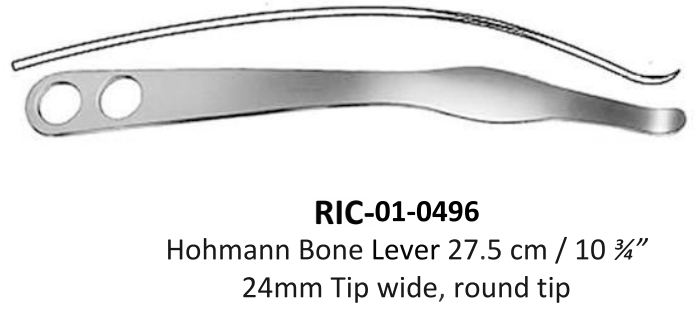
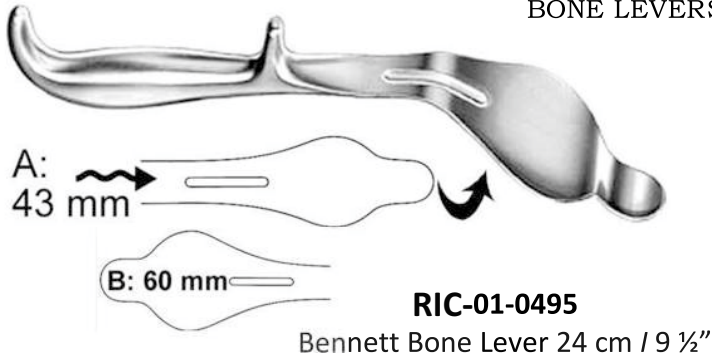

Sizes Available:

- A: 75 X 30 mm
- B: 100 X 30 mm

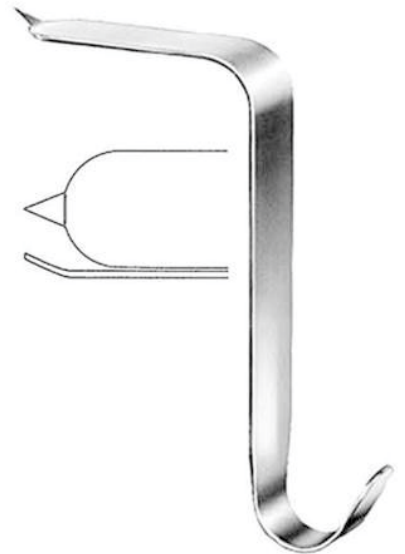

BONE LEVERS - RETRACTORS

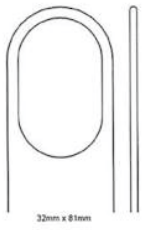

RIC-01-0504
Fukuda Retractor
19 cm / 7 1/2"
T-Handle

A: 32X81mm
B: 38X81mm

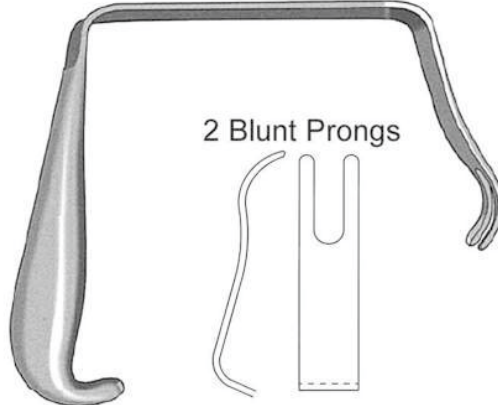

RIC-01-0505
Bristow / Bankart Humeral Retractor
18 cm / 7"



RIC-01-0506
Z Knee Retractor 15 cm / 6"
Medium Blade:
57 / 69mm Deep
11mm Wide
Large Blade:
63 / 76mm Deep
11mm Wide



RIC-01-0507
Deltoid Retractor 28 cm / 11" T Handle w / Ring



RIC-01-0508
Humeral Head Retractor 18 cm / 7" Strong Curved
2 Blunt Prongs

22 mm Blade
1 Sharp Prong

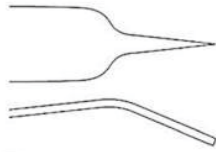

11-01-0509
Capsule Retractor 25 cm / 10"

22 mm Blade
2 Sharp Prong

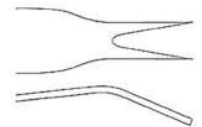

RIC-01-0510
Capsule Retractor 25 cm / 10"

3 Sharp Prongs

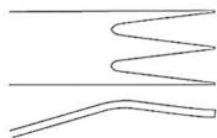

RIC-01-0511
Capsule Retractor 25 cm / 10"

Soft Tissue Retractor
3 Blunt Prong

22mm
Blade

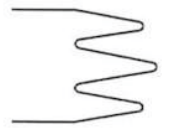

RIC-01-0512
Bristow / Bankart 19 cm / 7 1/2"

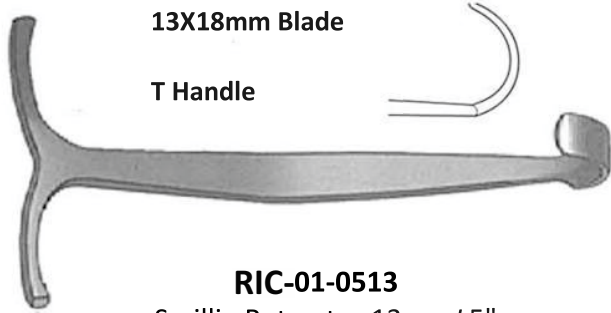

13X18mm Blade

T Handle

RIC-01-0513

Smillie Retractor 13 cm / 5"



13X55 mm Blade

T Handle

RIC-01-0514

Smillie Retractor 14 cm / 5 1/2"

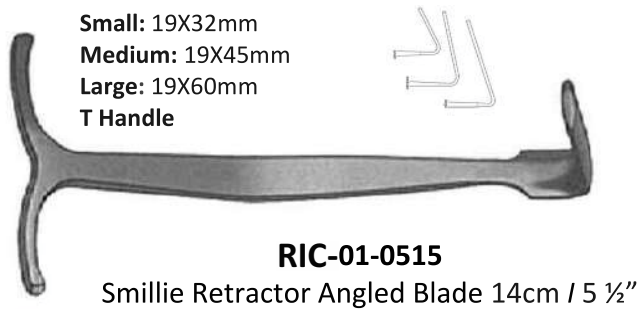

Small: 19X32mm
Medium: 19X45mm
Large: 19X60mm
T Handle

RIC-01-0515

Smillie Retractor Angled Blade 14cm / 5 1/2"

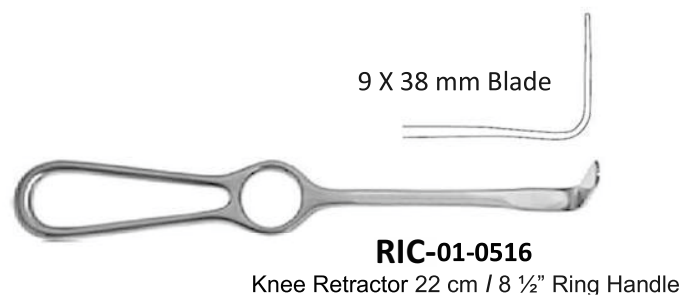

9 X 38 mm Blade

RIC-01-0516

Knee Retractor 22 cm / 8 1/2" Ring Handle

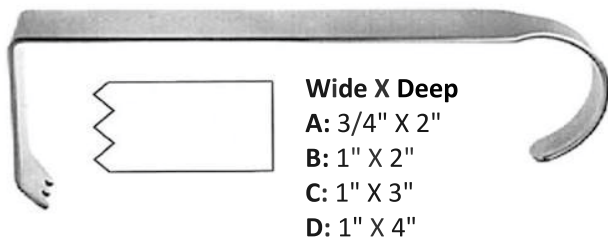

Wide X Deep

A: 3/4" X 2"
B: 1" X 2"
C: 1" X 3"
D: 1" X 4"

RIC-01-0517

Hibbs Retractor 24 cm / 9 1/2" Sharp Teeth

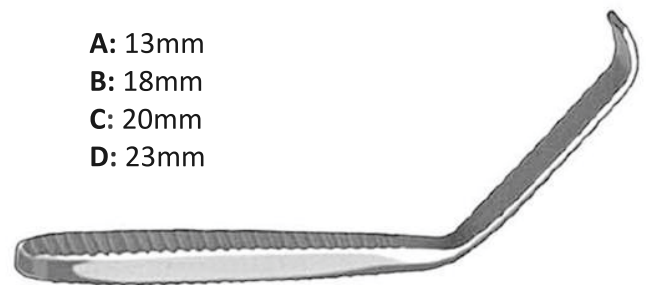

A: 13mm

B: 18mm

C: 20mm

D: 23mm

RIC-01-0518

Blade Retractor 19 cm / 7 1/2"

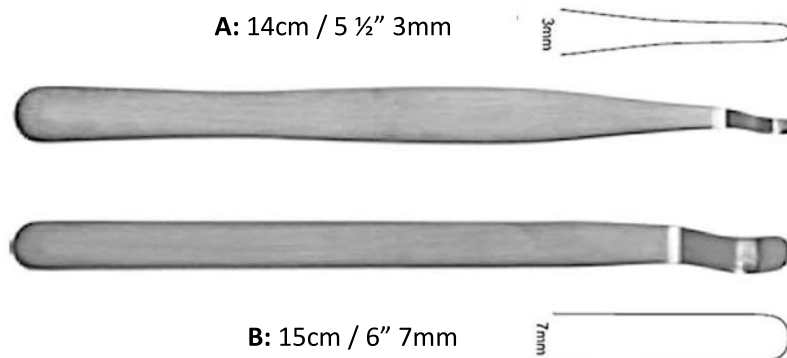

A: 14cm / 5 1/2" 3mm

B: 15cm / 6" 7mm

RIC-01-0519 Hayes Retractor

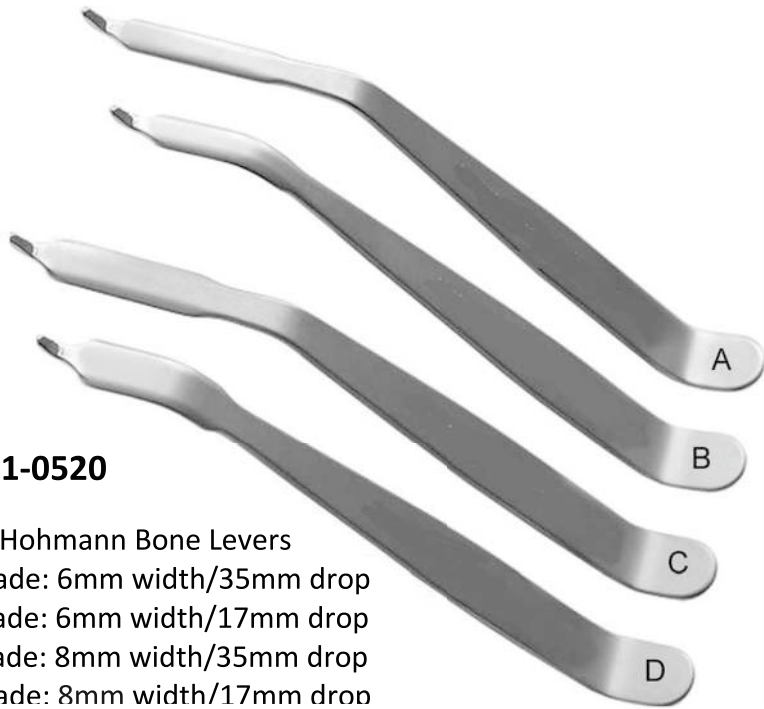

RIC-01-0520

Mini Hohmann Bone Levers

- A: Blade: 6mm width/35mm drop
- B: Blade: 6mm width/17mm drop
- C: Blade: 8mm width/35mm drop
- D: Blade: 8mm width/17mm drop

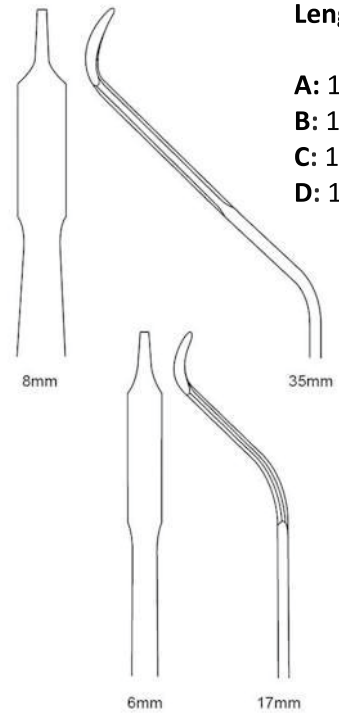

Length:

- A: 15cm / 6"
- B: 15.5cm / 6 1/4"
- C: 15cm / 6"
- D: 15.5cm / 6 1/4"

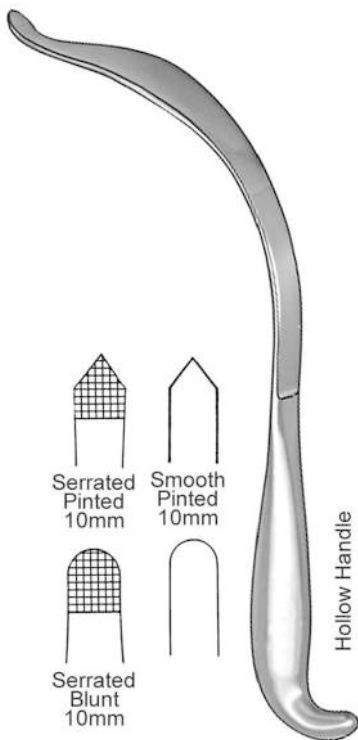

RIC-01-0521

Aufranc Cobra Retractor
26 cm / 10 1/2"

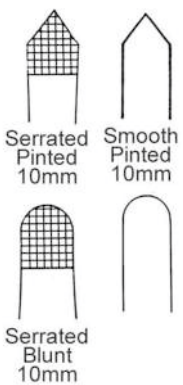

Hollow Handle

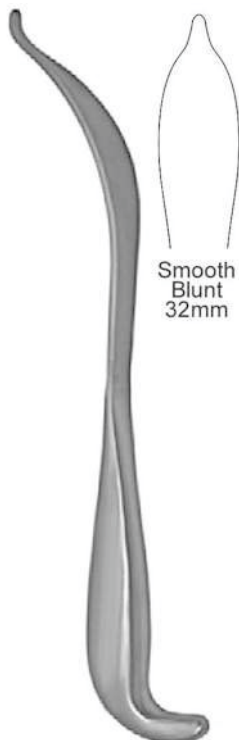

RIC-01-0522

Aufranc Cobra Retractor
27.5cm / 11"

Smooth
Blunt
32mm

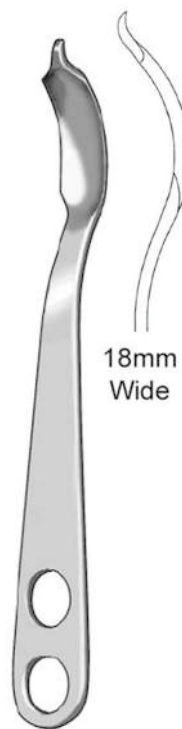

RIC-01-0523

Humeral Head Retractor
23 cm / 9"

18mm
Wide

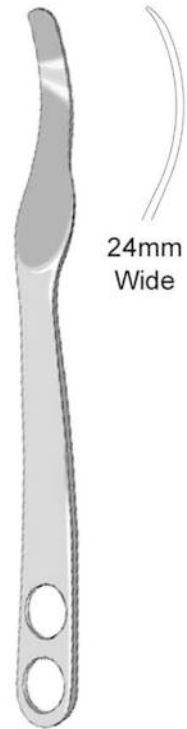

RIC-01-0524

Pelvic Retractor Single Prong
26 cm / 10 1/2"

24mm
Wide

BONE LEVERS - RETRACTORS



RIC-01-0525
Ribbon Retractor Malleable
30 cm / 12"

AVAILABLE SIZES:

- | | | |
|-------------------------|----------------------|----------------------|
| A: 6" X 6mm | G: 8" X 10mm | M: 13" X 38mm |
| B: 6" X 12mm | H: 8" X 12mm | N: 13" X 45mm |
| C: 6" X 16mm | I: 8" X 16mm | O: 13" X 50mm |
| D: 6" X 19mm | J: 8" X 19mm | P: 13" X 65mm |
| E: 7 1/2" X 25mm | K: 13" X 19mm | Q: 13" X 75mm |
| F: 8" X 6mm | L: 13" X 30mm | |



RIC-01-0526
Murphy Bone Skid
30 cm / 12"

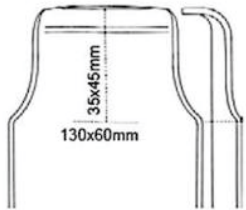

A: 29cm / 11 1/2" With Lip

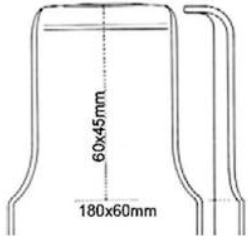

B: 33cm / 13" With Lip

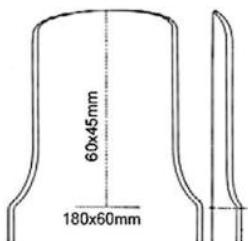

C: 33cm / 13" Without Lip



RIC-01-0527
St. Mark's Pelvic Retractor
Angled Blade

- A:** 22mm Blade
2 Finger Rings Long Round
- B:** 22mm Blade
1 Finger Ring Short Round

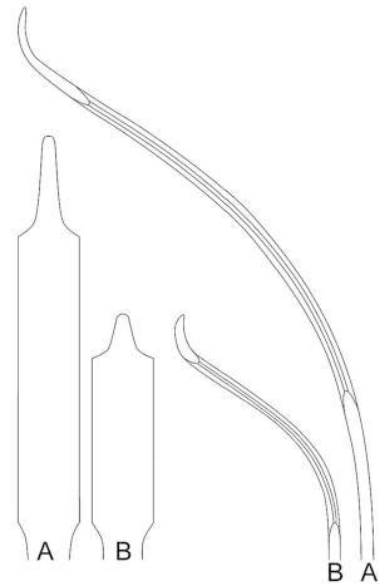
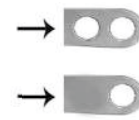

RIC-01-0528
Hohmann Retractor
40cm / 16"

BONE LEVERS - RETRACTORS

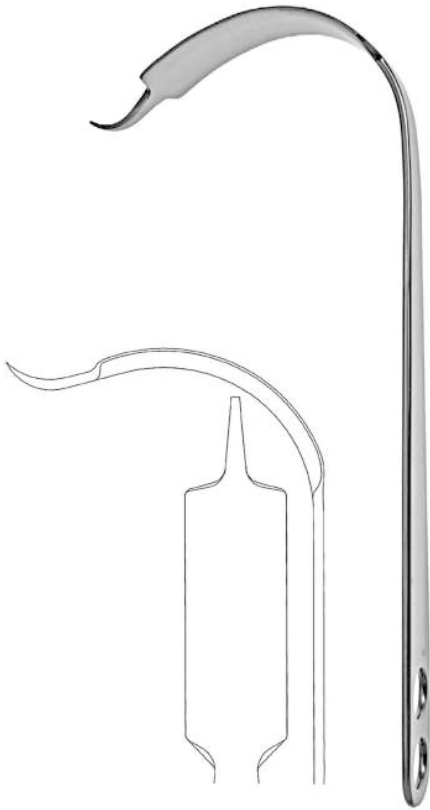

RIC-01-0529
Hohmann Retractor
33 cm / 13"



RIC-01-0530
Virchow Skull Breaker
7.5 cm / 3" 40 mm Blade Width

RIC-01-0531

Buckley Chisel
16cm / 6 1/4"
Octagonal handle

Fig A: 2mm
Fig B: 3mm
Fig C: 4mm



RIC-01-0532

Buckley Gouge
16cm / 6 1/4"
Octagonal handle

Fig A: 2mm
Fig B: 3mm
Fig C: 4mm

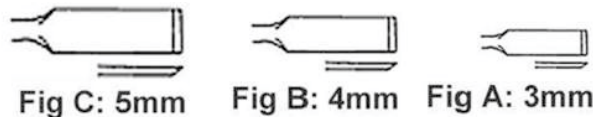

RIC-01-0533

Stout Bone Chisel 21 cm / 8 1/4" octagonal handle



RIC-01-0534

Bone Chisel 18 cm / 7" Round Handle

4mm



RIC-01-0535

Bone Chisel 17 cm / 6 3/4" Round Handle

4mm

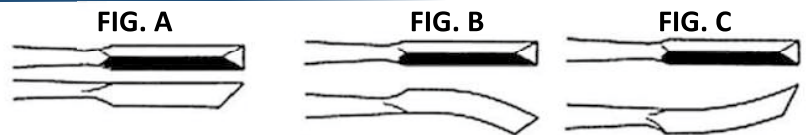

RIC-01-0536

Gardner Bone Chisel 17 cm / 6 3/4" 4 mm



CHISELS - OSTEOTOMES - GOUGES

FIG A: 3 mm

FIG B: 5 mm

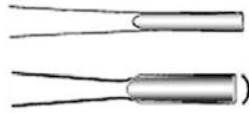

RIC-01-0537

Snyder-O.S.U Bone Chisel 16.5 cm / 6 1/2" 3 mm / 5 mm

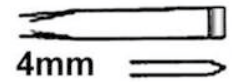

RIC-01-0538

Bone Chisel 18 cm / 7" Octagonal Handle 4 mm

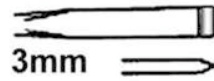

RIC-01-0539

Bone Chisel 18 cm / 7" Octagonal Handle 3 mm



FIG A

FIG B



RIC-01-0540

O.S.U. Bone Chisel 17 cm / 6 3/4" 7 mm / 9 mm

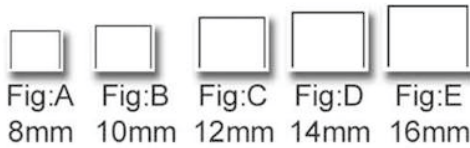

Side View



RIC-01-0541

Osteotome 13.5 cm / 5 1/4"

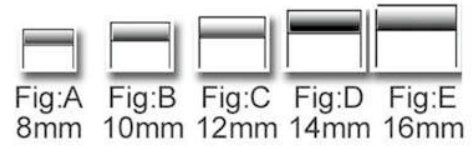

Side View



RIC-01-0542

Chisel 13.5 cm / 5 1/4"

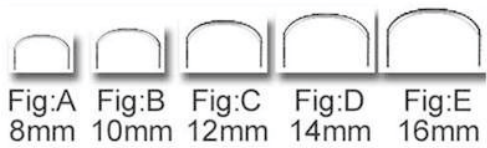

Side View



RIC-01-0543

Gouge 13.5 cm / 5 1/4"

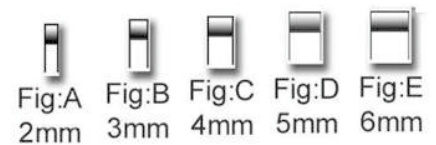

Side View



RIC-01-0544 Partsch Chisel 13.5 cm / 5 1/4"

RIC-01-0545 Partsch Chisel 17 cm / 6 3/4"

CHISELS - OSTEOTOMES - GOUGES

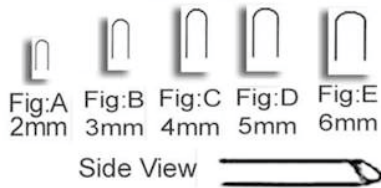

RIC-01-0546 Partsch Gouge 13.5 cm / 5 ¼"

RIC-01-0547 Partsch Gouge 13.5 cm / 5 ¼"

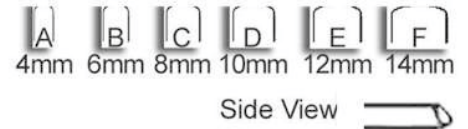

RIC-01-0548 Alexander Gouge 17.5 cm / 7"

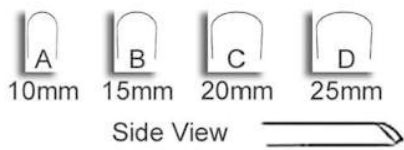

RIC-01-0549 Stille Gouge 20 cm / 8"

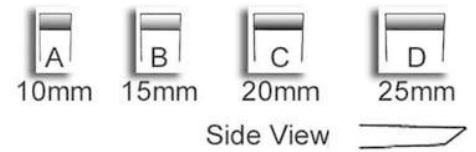

RIC-01-0550 Stille Chisel 20 cm / 8"

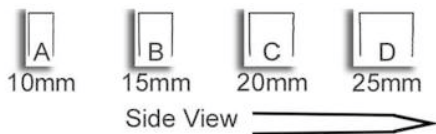

RIC-01-0551 Stille Osteotome 20 cm / 8"

RIC-01-555
Lambotte, Osteotome
24 cm / 9 ½"
Curved Tip



Side View
Curved Tip



Available in

- 15mm
- 20mm
- 25mm
- 30mm
- 38mm
- 44mm
- 50mm

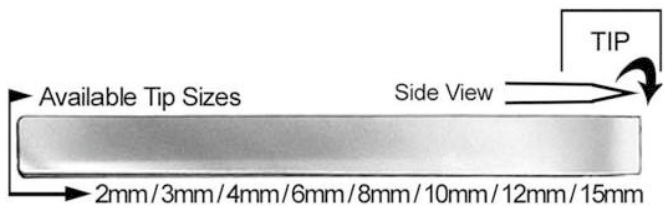

RIC-01-0552 (12.5 cm / 5") Lambotte, Mini Osteotome

RIC-01-0553 (17 cm / 6 ¾") Lambotte, Mini Osteotome
3mm / 4mm / 6mm / 8mm / 10mm / 12mm / 15mm

RIC-01-0554 (24 cm / 9 ½") Lambotte, Osteotome
15mm / 20mm / 25mm / 30mm / 38mm / 44mm / 50mm

CHISELS - OSTEOTOMES - GOUGES

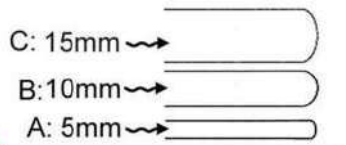

RIC-01-0556A
Lexer Spongiosa Gouge (25 cm / 9 ¾")

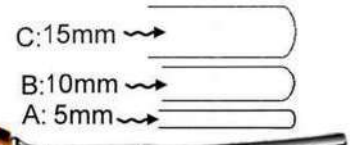

RIC-01-0556B
Lexer Spongiosa Gouge (25 cm / 9 ¾")

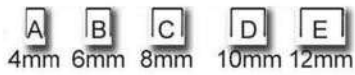

RIC-01-0557A
Lexer, Mini Osteotome 18.5 cm / 7 ¼"



RIC-01-0557B
Lexer, Mini Osteotome 18.5 cm / 7 ¼"

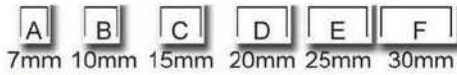

RIC-01-0558A
Lexer, Osteotome 22 cm / 8 ¾"



RIC-01-0558B
Lexer, Osteotome 22 cm / 8 ¾"



RIC-01-0559
Vickers Spongiosa Gouge 18 cm / 7"



RIC-01-0560A
US Army Chisel 18 cm / 7"



RIC-01-0560B
US Army Osteotome 18 cm / 7"



RIC-01-0560C
US Army Gouge 18 cm / 7"



RIC-01-0561A
Smith-Petersen Osteotome 20.5 cm / 8" Straight



RIC-01-0561B
Smith-Petersen Osteotome 20.5 cm / 8" Curved

CHISELS - OSTEOTOMES - GOUGES



RIC-01-0561C
Smith-Petersen Gouge 20.5 cm / 8" Straight Tip

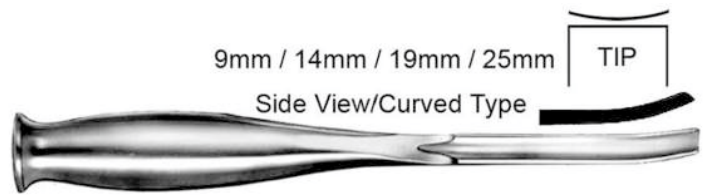

RIC-01-0561D
Smith-Petersen Gouge 20.5 cm / 8" Curved Tip



RIC-01-0562
Hook Osteotome 17 cm / 6 3/4"

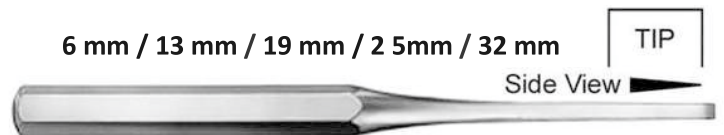

RIC-01-0563A
Hibbs Osteotome 24.5 cm / 9 3/4"

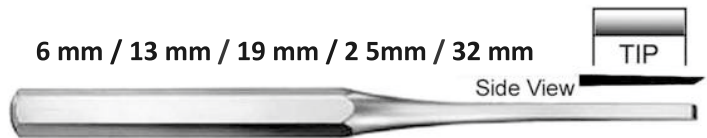

RIC-01-0563B
Hibbs Chisel 24.5 cm / 9 3/4"



RIC-01-0563C
Hibbs Gouge 24.5 cm / 9 3/4"

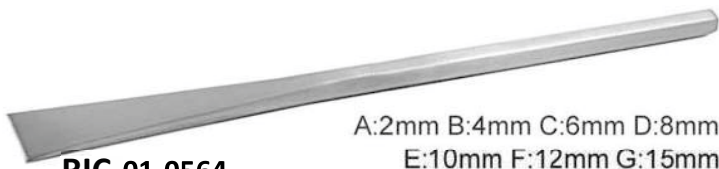

RIC-01-0564
Sheehan Osteotome 16cm / 6 1/2"



RIC-01-0565A
Silver Osteotome 18 cm / 7" Straight



RIC-01-0565B
Silver Osteotome 18 cm / 7" Curved Right



RIC-01-0565C
Silver Osteotome 18 cm / 7" Curved Left



RIC-01-0566
Shoulder Penetrating Gouge 21 cm / 8 1/2"



RIC-01-0567
Swan Neck Gouge 23 cm / 9"

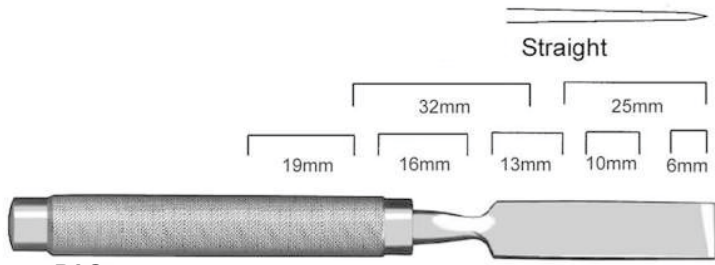

RIC-01-0568A

Cobb Osteotome 28 cm / 11" Straight

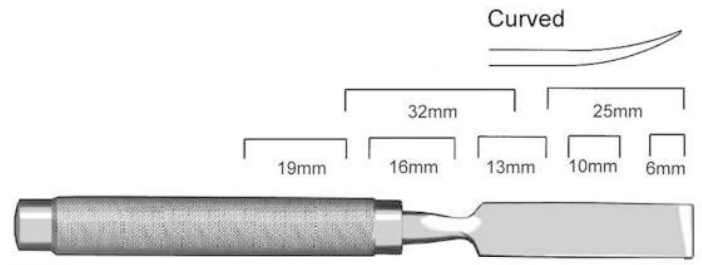

RIC-01-0568B

Cobb Osteotome 28 cm / 11" Curved

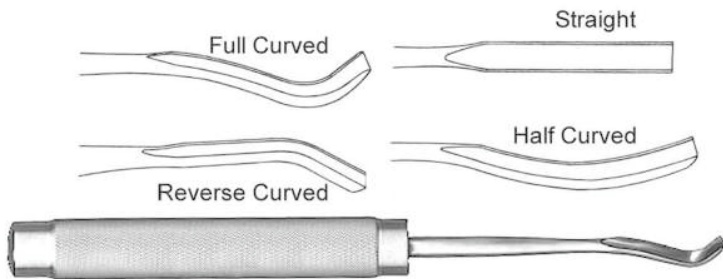

RIC-01-0569

Cobb Gouge 28 cm / 11"

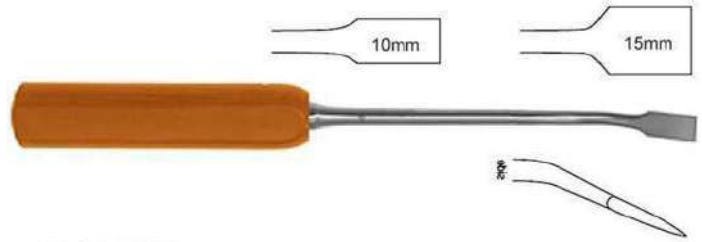

RIC-01-0570

Lexer Osteotome Angled / 28 cm / 11"

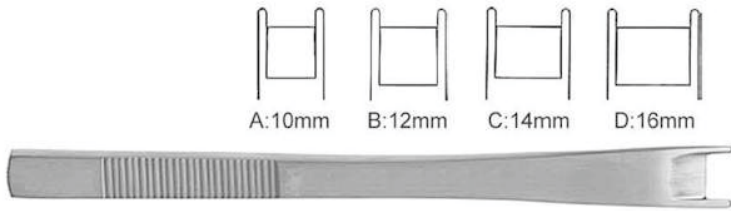

RIC-01-0571

Cinelli Osteotome 15.5 cm / 6 1/2"

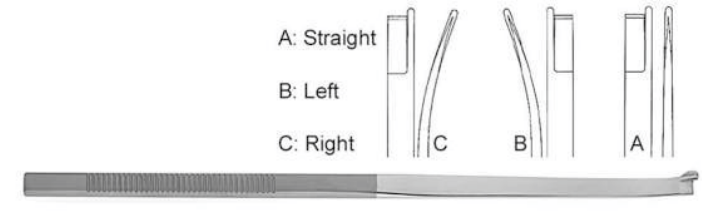

RIC-01-0572

Anderson Neivert Osteotome 20 cm / 8"

RIC-01-0573

Hibbs Osteotome 47 cm / 18 1/2" 10 mm Tip
3 1/2" Tip L / 10 3/4" Shaft L / 4 1/4" Handle L
11.5 mm Shaft Diameter



RIC-01-0574

Hibbs Gouge 47 cm / 18 1/2" 10 mm Tip
3 1/2" Tip L / 10 3/4" Shaft L / 4 1/4" Handle L
11.5 mm Shaft Diameter

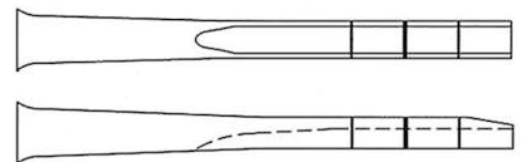

CHISELS - OSTEOTOMES - GOUGES



RIC-01-0575

Spinal Fusion Gouge 24 cm / 9 1/2" 6 mm Tip

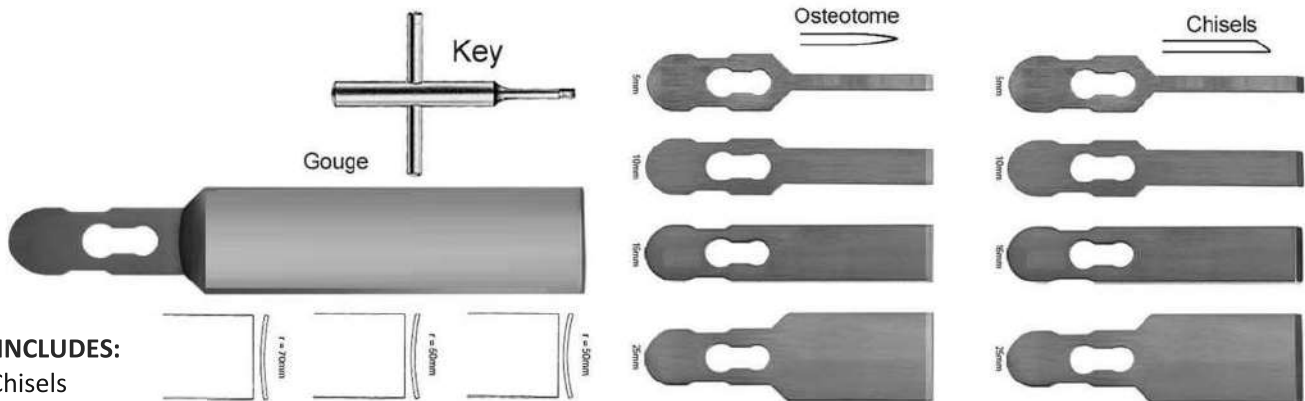

SET INCLUDES:

- 5 x Chisels
5/1 0/15/25mm
- 5 x Osteotomes
5/1 0/15/25mm
- 3 x Gouges
50/60/70mm Radius
- 1 x Handle Fibre
- 1 x Key



RIC-01-0576

Chisel Handle Fibre w/Chisel-Osteotome-Gouge Blades 18.5 cm / 7 1/4"

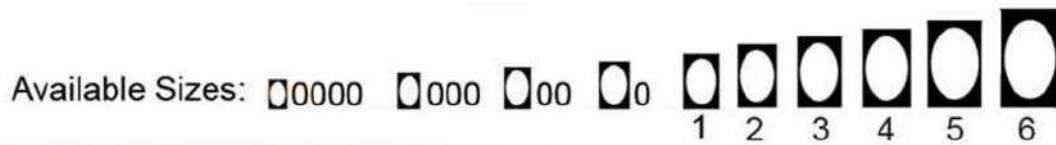

RIC-01-0577

Volkman Bone Curette 18.5 cm / 7 1/4" oval with plastic handle

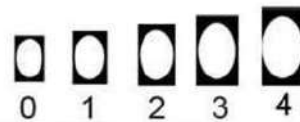

RIC-01-0578

Volkman Bone Curette 27.5 cm / 10 3/4" oval with plastic handle

BONE CURETTES

A: 13 cm / 5"
 B: 16 cm / 6 ¼"
 C: 20 cm / 8"

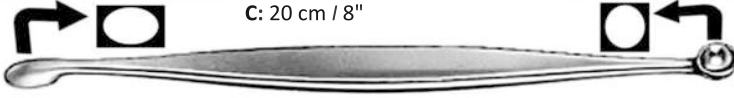

RIC-01-0579

Volkman Bone Curette, double-ended (oval / round)



RIC-01-0580

Bone Curette, double-ended (round / oval) 21 cm / 8 ¼"



11-01-0581

Schede Bone Curette 17 cm / 6 ¾" oval with hollow handle

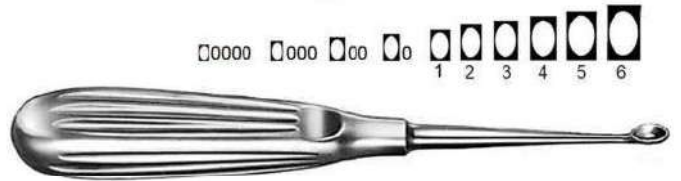

RIC-01-0582

Volkman Bone Curette 17 cm / 6 ¾" oval, with hollow handle

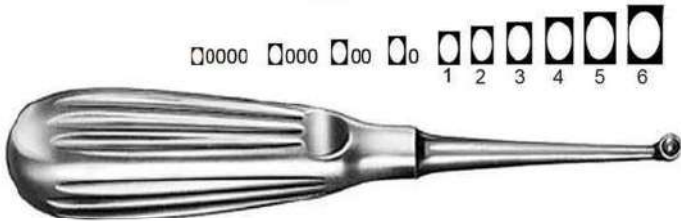

RIC-01-0583

Bruns Bone Curette 17 cm / 6 ¾" Round, with hollow handle

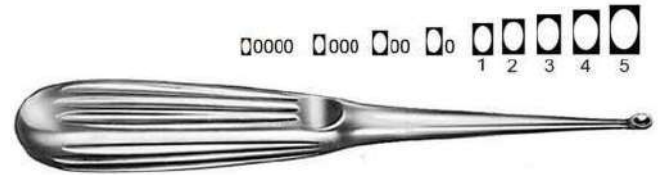

RIC-01-0584

Spratt Bone Curette 17 cm / 6 ¾" Oval, with hollow handle

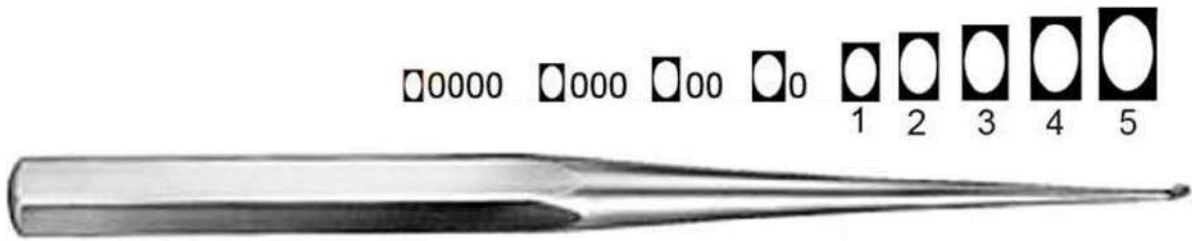

RIC-01-0585

Bruns Bone Curette 23 cm / 9" oval, solid



RIC-01-0586

Scoville Bone Curette 25 cm / 9 ¾" oval, with hollow handle

BONE CURETTES



RIC-01-0587

Simon Bone Curette 25 cm / 9 ¾" oval, with hollow handle



RIC-01-0588

Modell USA Bone Curette 16 cm / 6 ¼" Oval, with hollow handle



RIC-01-0589

Modell USA Bone Curette 15.5 cm / 6" Oval, with hollow handle



RIC-01-0590

Model USA Bone Curette 15.5 cm / 6" Oval, with hollow handle

BONE CURETTES



RIC-01-0591

Halle Bone Curette 21 cm / 8 1/4" oval, malleable shaft, with hollow handle

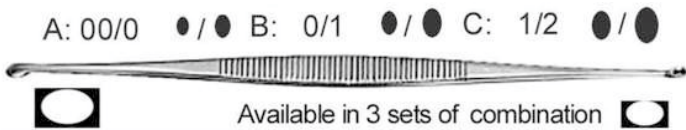

RIC-01-0592

Williger Bone Curette, double-ended 13.5 cm / 5 1/4" handle

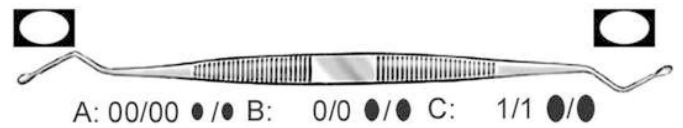

RIC-01-0593

Williger Bone Curette, 17 cm / 6 3/4" double-ended oval / oval



RIC-01-0594

A: 12.5 cm / 5"
B: 14.5 cm / 5 3/4"
C: 17 cm / 6 3/4"
Volkmann Bone Curette, double-ended



RIC-01-0595

Hemingway-Martin Bone Curette, double-ended
18.5 cm / 7 1/4"



RIC-01-0596

Bone Curette, 17.5 cm / 7" double-ended round



RIC-01-0597

Hemingway Bone Curette, double-ended, round / round
18.5 cm / 7 1/4" octagonal handle

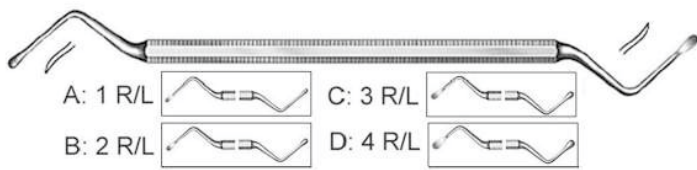

RIC-01-0598

Lucas Bone Curette, double-ended 18 cm / 7"
Octagonal handle

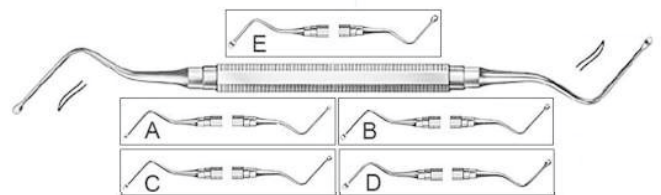

RIC-01-0599

Miller-Colburn Bone Curette, double-ended 17 cm / 6 3/4"

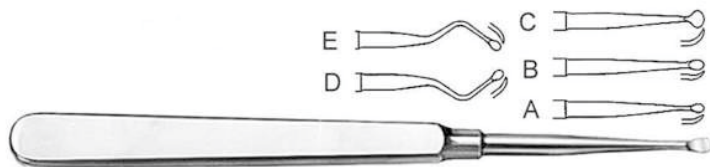

RIC-01-0600

Molt Bone Curette 17 cm / 6 3/4"

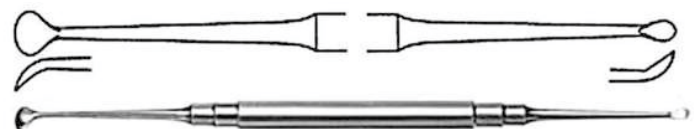

RIC-01-0601

Molt Bone Curette 19 cm / 7 1/2" Round Handle

BONE CURETTES

Hollow Handle
Oval Fenestrated
4X7mm Cup
Sharp/Blunt

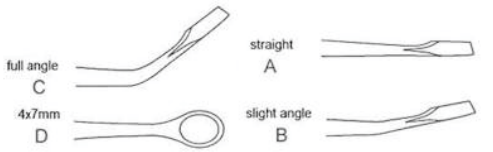

RIC-01-0602

Semmes Ring Curette 23 cm / 9"

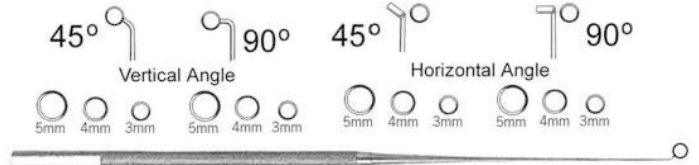

RIC-01-0603

Ray Pituitary Curette 18 cm / 7 1/2"

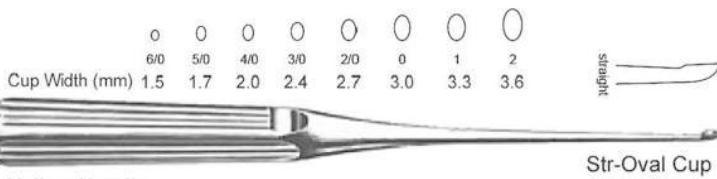

RIC-01-0604

Lempert Curette 18 cm / 7 1/2"

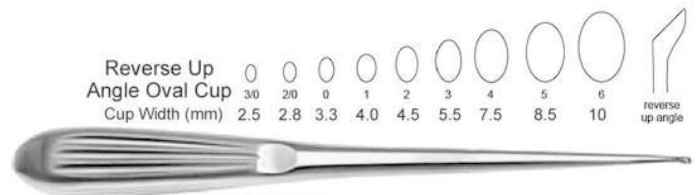

Hollow Handle

RIC-01-0605

Epstein Curette 18 cm / 7 1/2"

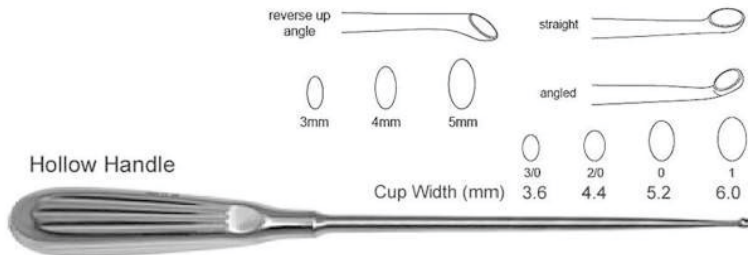

RIC-01-0606

Bushe Curette 25 cm / 10"

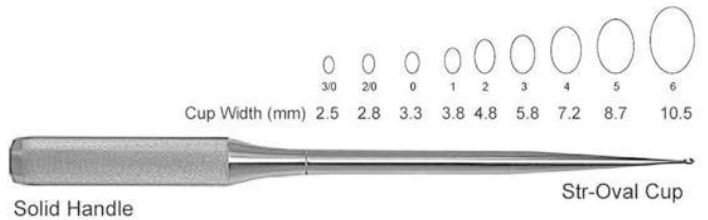

Solid Handle

RIC-01-0607

Spinal Fusion Curette 28 cm / 11"

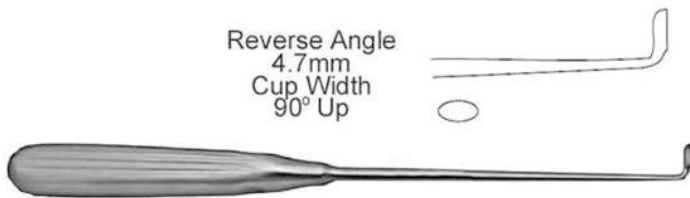

RIC-01-0608

Scoville Curette 25 cm / 10"

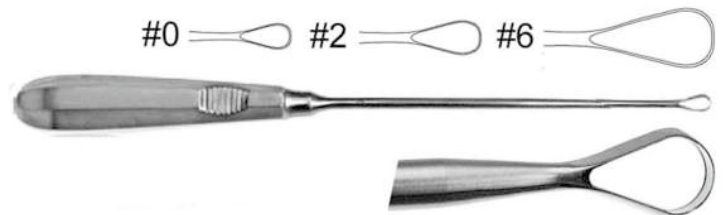

RIC-01-0609

Ring Curette

- A: 25 cm / 10" #0 6mm Cup
- B: 25 cm / 10" #2 8mm Cup
- C: 26 cm / 10 1/2" #6 14mm Cup
- D: 28 cm / 11 1/2" #0 6mm Cup
- E: 28 cm / 11 1/2" #2 8mm Cup
- F: 30 cm / 12 1/2" #6 14mm Cup

BONE CURETTES

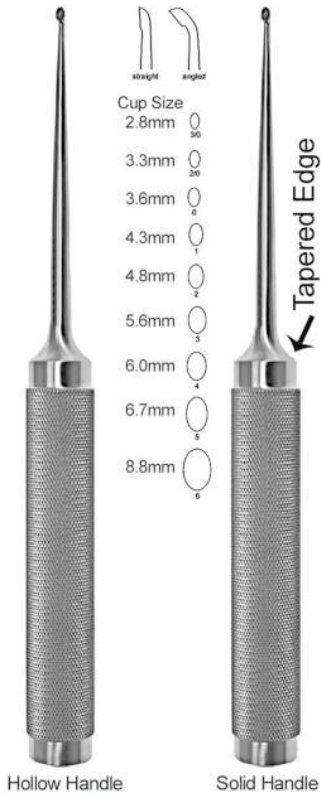

RIC-01-0610

Cobb Curette Oval Cups
28 cm / 11"

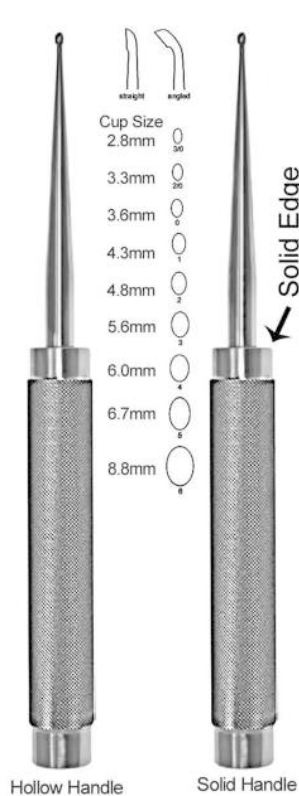

RIC-01-0611

Cobb Curette Oval Cups
28 cm / 11"



RIC-01-0612

Sybert Curette Long
Delicate Shaft



RIC-01-0613

Cone Ring Curette
23 cm / 9"

- A: Straight 8mm Sharp/Blunt
- B: Straight 11 mm Sharp/Blunt
- C: Angled 8mm Sharp/Sharp
- D: Angled 11 mm Sharp/Sharp
- E: Angled 8mm Sharp/Sharp Right Cvd

- F: Angled 11 mm Sharp/Sharp Right Cvd
- G: Angled 8mm Sharp/Sharp Left Cvd
- H: Angled 11 mm Sharp/Sharp Left Cvd



RIC-01-0614

Zielke Ring Curette 34 cm / 13 1/2" TEFLON Handle

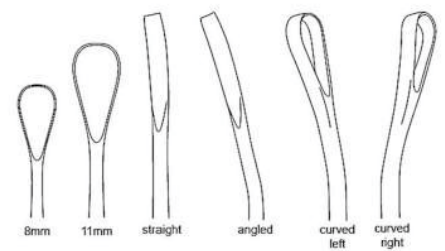

17" Angled 40° 3mm Diameter 2.7"
Tip Length Cone Ring Curette
Endoscopic Fibre Handle 9.3" Shaft
Length 5" Handle Length .285 (7
.2mm) Shaft Diameter

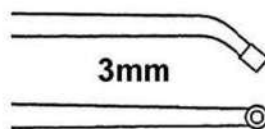

3mm

20" Angled 30°
6mm Diameter
3 1/2" Tip Length
10" Shaft Length
6 1/2" Handle Length
45" (11.5mm)
Shaft Diameter

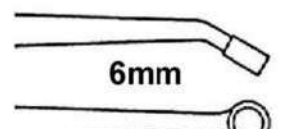

6mm



RIC-01-0615

Cone Ring Curette Endoscopic Fibre Handle

BONE CURETTES

17" Reverse Angled 40° 3mm x 6mm cup
2.7" Tip Length 9.3" Shaft Length 5" Handle
Length.285 (7.2mm) Shaft Diameter

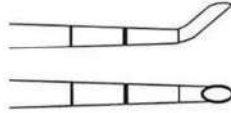

20" Reverse Angled 30°
6mm x 9mm cup 3 1/2"
Tip Length 10" Shaft
Length 6 1/2" Handle
Length .45 (7.2mm)
Shaft Diameter

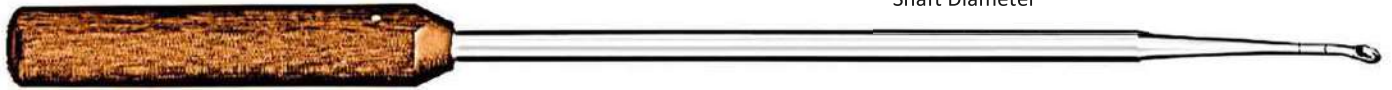
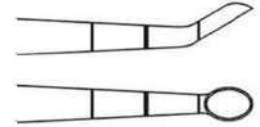

RIC-01-0616

Epstein Curette Endoscopic Fibre Handle

A: 17cm / 6 3/4" 8mm | B: 19cm / 7 1/2" 16 mm | E: 18.5cm / 7" 12 mm
C: 19cm / 7 1/2" 16 mm | D: 18.5cm / 7 1/4" 12 mm

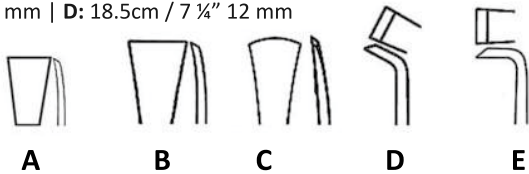

RIC-01-0617

Martin-Langenbeck Periosteal Elevator (Solid)

B: 18.5cm / 7 1/4" 15mm tip
C: 19cm / 7 1/2" 20 mm tip
A: 16cm / 6 1/4" 7mm

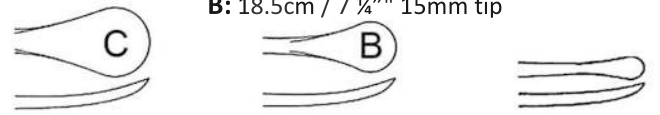

RIC-01-0618

Martin-Langenbeck Periosteal Elevator (Solid)

19.5cm / 7 3/4" C:7mm 4mm tip
6mm tip
19.5cm / 7 3/4" C:6mm 17.5cm / 7" B
7mm tip 5mm tip



RIC-01-0619

Martin-Langenbeck Periosteal Elevator (Solid)



RIC-01-0620

Langenbeck Periosteal Elevator 18.5 cm / 7 1/4"
With hollow handle



RIC-01-0621

Langenbeck Periosteal Elevator 19.5 cm / 7 3/4"
With hollow handle

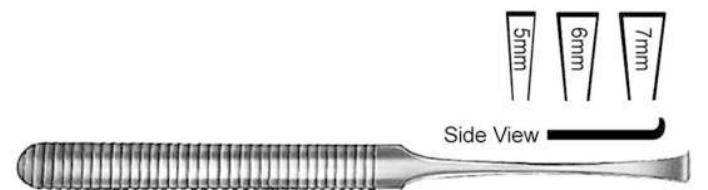

RIC-01-0622

Periosteal Elevator 16 cm / 6 1/4" Delicate, solid

PERIOSTEAL ELEVATORS



RIC-01-0623

Farabeuf Periosteal Elevator 15 cm / 6"
With hollow handle



RIC-01-0624

Periosteal Elevator 3mm Tip 18 cm / 7"
Extra narrow, with plastic handle

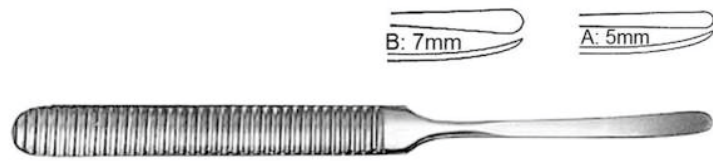

RIC-01-0625

Kahre-Williger 16 cm / 6 1/4"
Periosteal Elevator solid



RIC-01-0626

Kahre-Williger Periosteal Elevator solid
16cm / 6 1/4"



RIC-01-0627

Farabeuf Periosteal Elevator
15 cm / 6" with hollow handle



RIC-01-0628

Sedillot Periosteal Elevator 22 cm / 8 3/4" (15mm tip)



RIC-01-0629

Periosteal Elevator 20 cm / 8" (14 mm Tip)
With plastic handle



RIC-01-0630

Periosteal Elevator 19 cm / 7 1/2"
(14 mm Tip) with plastic handle



RIC-01-0631

Periosteal Elevator 6mm Tip
18 cm / 7" narrow, plastic handle



RIC-01-0632

Periosteal Elevator 18 cm / 7" narrow,
Plastic handle (6mm Tip)

PERIOSTEAL ELEVATORS - DISSECTORS



RIC-01-0633

Williger Periosteal Elevator
12.5 cm / 5" solid 5mm Tip



RIC-01-0634

Periosteal Elevator,
Double ended 17.5 cm / 7"

RIC-01-0635

Semb Periosteal Elevator

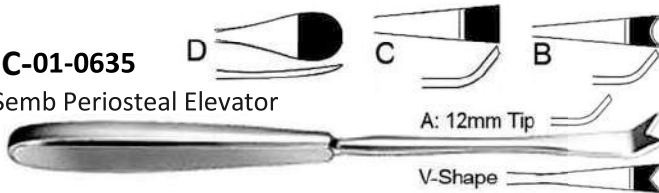

A+D: 21cm / 8 1/4" & **B+C:** 18.5 cm / 7 1/4"
A: V-shape 12mm | **B:** Inside round 12mm
C: Straight 13mm | **D:** Outer round 15mm

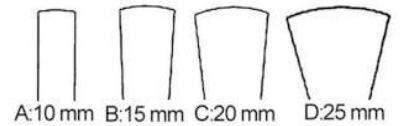

RIC-01-0636

Lambotte Periosteal Elevator 21.5 cm / 8 1/2"



RIC-01-0637

Periosteal Elevator 20 cm / 8" with plastic handle

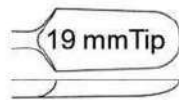

RIC-01-0638

Periosteal Elevator 17 cm / 6 3/4" with hollow handle

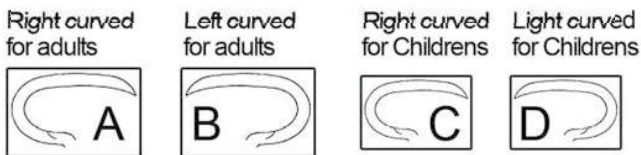
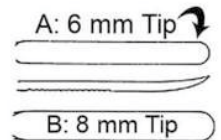

RIC-01-0639

Doyen Rib Raspatory 17.5 cm / 7" Rib Raspatories with hollow handle

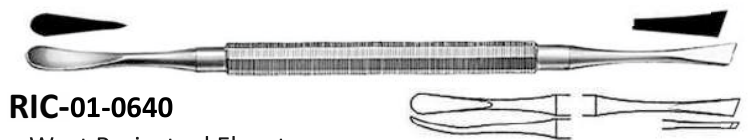
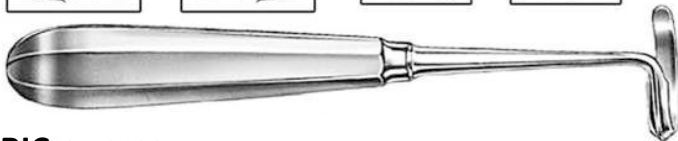

RIC-01-0640

West Periosteal Elevator,
Double-ended 18.5 cm / 7 1/4" octagonal handle

RIC-01-0641

Williger Elevator
17 cm / 6 3/4" 7mm tip



RIC-01-0642

Williger Elevator
16 cm / 6 1/4" (5.5mm tip)



RIC-01-0643

Elevator 17 cm / 6 3/4" Light weight



PERIOSTEAL ELEVATORS - DISSECTORS

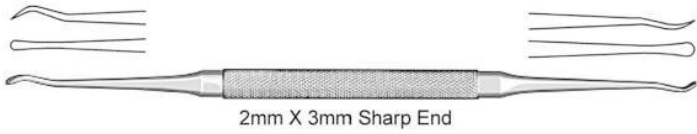

RIC-01-0644
Kleinert Kutz Elevator 14 cm / 5 1/2"

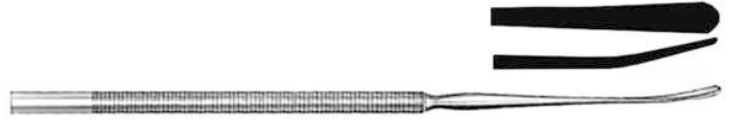

RIC-01-0645
Vickers Dissector 17 cm / 6 3/4"

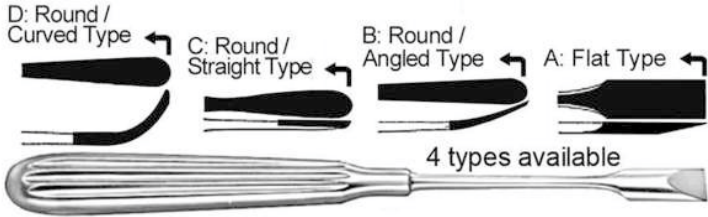

RIC-01-0646
Adson Elevator 17.5 cm / 7" A/B/C/D

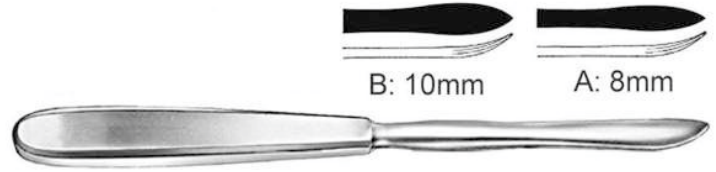

RIC-01-0647
Langenbeck Elevator 19.5 cm / 7 3/4" A/B

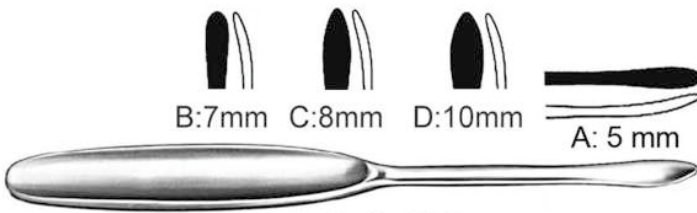

RIC-01-0648
Martin Langenbeck Elevator 17 cm / 6 3/4" A/B/C | D: 19.5 cm / 7 3/4"



RIC-01-0649
Phalangeal Elevator 16cm / 6 1/4"



RIC-01-0650
Alderdyce Dissector, double-ended 21 cm / 8 1/4"



RIC-01-0651
McDonald Dissector, double-ended 18.5 cm / 7 1/4"



RIC-01-0652
Freer Elevator 19 cm / 7 1/2"



RIC-01-0653
Penfield Elevator Endoscopic 38 cm / 15" 5mm Semi Sharp / 1X10mm Blunt Hook



RIC-01-0654
Smithwick Hook and Dissector 30 cm / 12" 5mm Semi Sharp / 1X10mm Blunt Hook

PERIOSTEAL ELEVATORS - RESPIATORIES

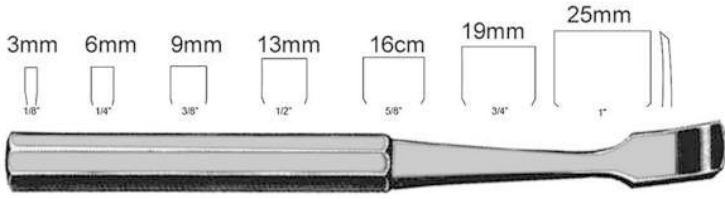

RIC-01-0655

Key Elevator 19 cm / 7 1/2" Sharp Edge

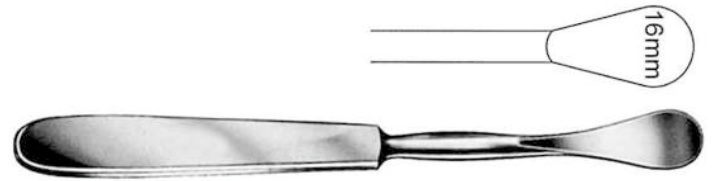

RIC-01-0656

Sedilot Elevator 18 cm / 7" Sharp Edge



RIC-01-0657

Alexander Periosteal Respiratory 20 cm / 8" / 12mm Sharp

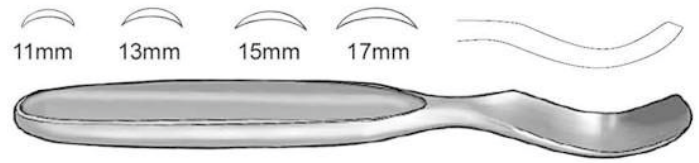

RIC-01-0658

MeGiamry Metatarsal Elevator 16 cm / 6 1/2" Sharp

- A: 19cm / 7 1/2" 13mm
- B: 20cm / 8" 19mm
- C: 23cm / 9" 25mm
- D: 25.5cm / 10" 30mm

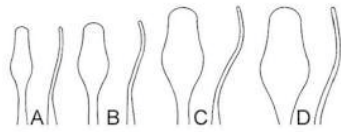

RIC-01-0659

Chandler Elevator Blunt



RIC-01-0660

Sayre Elevator 16 cm / 6 1/2"
A: Sharp / Blunt B: Blunt/ Blunt

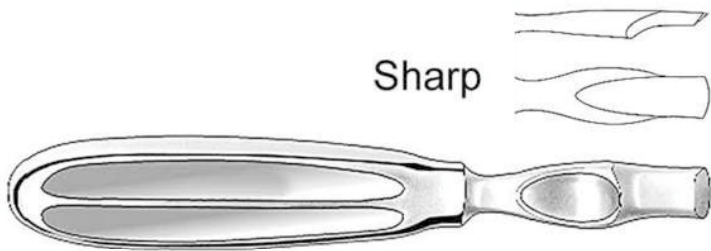

RIC-01-0661

Kirmission Periosteal Respiratory 17 cm / 6 3/4"

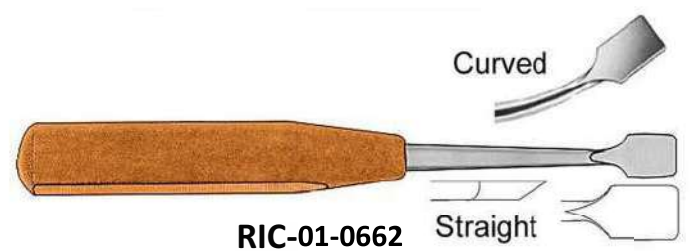

RIC-01-0662

Periosteal Elevator 17cm / 6 3/4" Fibre Handle
13mm Blade Sharp

- A: 14mm Full Curves
- B: 14mm Slight Curves
- C: 7mm Full Curves
- D: 7mm Slight Curves



RIC-01-0663

Crego Periosteal Elevator 19 cm / 7 3/4" Sharp

PERIOSTEAL ELEVATORS - DISSECTORS

Small

A: 26 cm / 10 ¼" 13mm Width at Tip

Medium

B: 26 cm / 10 ¼" 20mm Width at Tip

Large

C: 35 cm / 13 ¾" 25mm Width at Tip

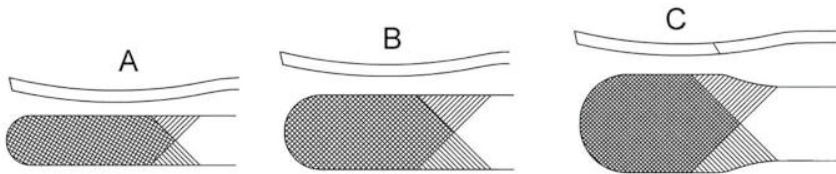

RIC-01-0664

Darraeh Elevator Blunt

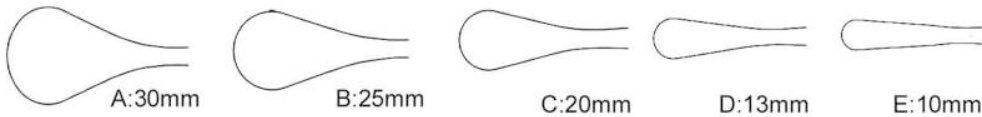

RIC-01-0665

Cobb Spinal Elevator Sharp 24cm / 9 ½" Hexa Handle

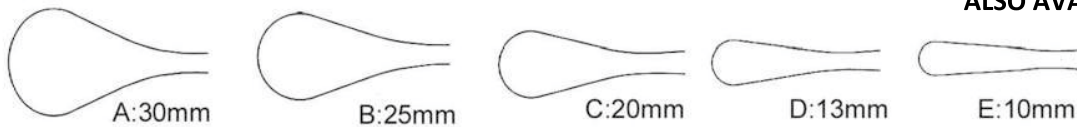

ALSO AVAILABLE WITH FIBRE HANDLE



RIC-01-0666

Spinal Elevator Sharp 28 cm / 11" Knurled Handle

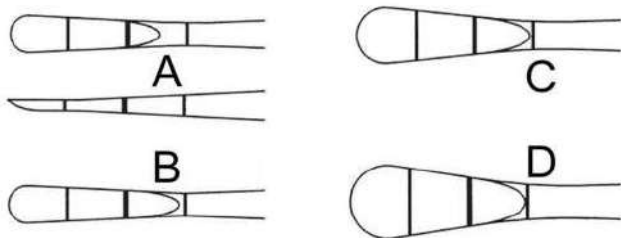

A: 43cm / 17"	B: 50cm / 20"	C: 50cm / 20"	D: 50cm / 20"
6mm Tip Width	6mm Tip Width	10mm Tip Width	13mm Tip Width
2.7" Tip Length	3 1/2" Tip Length	3 1/2" Tip Length	3 1/2" Tip Length
9.3" Shaft Length	10" Shaft Length	10" Shaft Length	10" Shaft Length
5" Handle Length	6 1/2" Handle L	6 1/2" Handle L	6 1/2" Handle L
7.2mm Shaft Dia	11.5mm Shaft Dia	11.5mm Shaft Dia	11.5mm Shaft Dia



RIC-01-0667

Cobb Elevator Endoscopic Sharp / Fibre Handle

ELEVATORS SPINAL – S/S & FIBRE

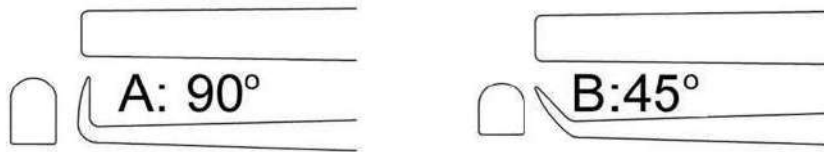

43 cm / 17" - 9mm Tip Radius - 4" Tip Length
8" Shaft Length - 5" Handle Length
11 .5mm Shaft Diameter



RIC-01-0668

Rib Elevator Endoscopic Sharp / Fibre Handle

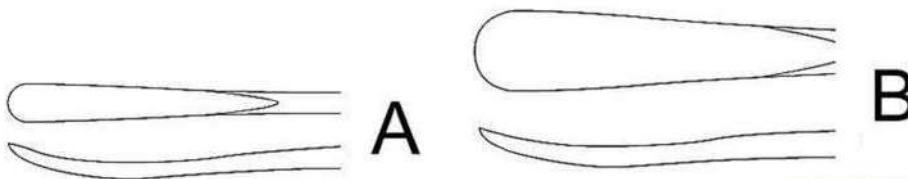

A: 8mm Wide
B: 17mm Wide



RIC-01-0669

Wagner Elevator Sharp / Fibre Handle 33 cm / 13"

A: 19mm \varnothing / 230 gms
B: 25mm \varnothing / 260 gms

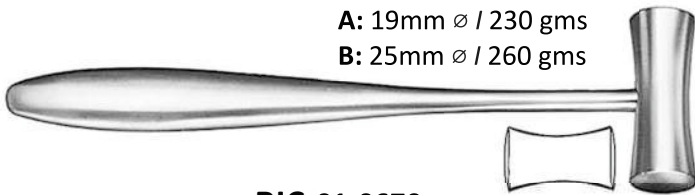

RIC-01-0670

Lucae Mallet 19.5 cm / 7 3/4"



RIC-01-0671

Cottle Mallet Plane / Convex
19 cm / 7 1/2" 30mm \varnothing / 300 gms

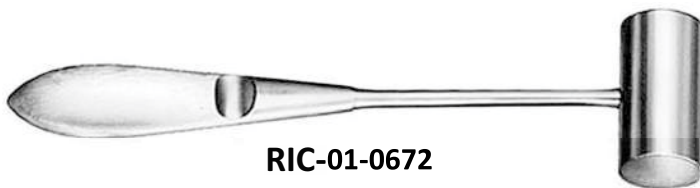

RIC-01-0672

Williger Mallet 16.4cm / 6 1/2"
20 mm \varnothing / 140 gms



RIC-01-0673

Mallet 26 cm / 10 1/4"
30 mm \varnothing / 510 gms



27mm \varnothing / 320 gms

RIC-01-0674

Mead Mallet 19 cm / 7 1/2"
With interchangeable plastic disks



RIC-01-0675

Partsch Mallet 19 cm / 7 1/2"
With hollow handle 22mm \varnothing / 200 gms

ORTHOPEDIC MALLETS – S/S & FIBRE



RIC-01-0676

Mallet 26 cm / 10 ¼" with lead filling
42mm ø / 400 gms



RIC-01-0677

Mallet 26 cm / 10 ¼" without lead filling
42mm ø / 400 gms

- A: 26mm ø / 300 gms
- B: 28mm ø / 340 gms
- C: 30mm ø / 400 gms



RIC-01-0678

Williger Mallet 24 cm / 9 ½" lead filled
42mm ø / 400 gms



RIC-01-0679

Mallet 30 mm ø / 675 gms
26.5 cm / 10 ½" plane (Teflon) / convex (steel)



RIC-01-0680

Mallet 26 cm / 10 ¼"
42 / 30mm ø / 530 gms



RIC-01-0681

Mallet 24 cm / 9 ½"
30 mm ø / 480 gms



RIC-01-0682

Mallet 24 cm / 9 ½"
Disks and handle of Fiber 37 mm ø / 370 gms



RIC-01-0683

Mallet 22 cm / 8 ¾"
30 mm ø / 125 gms



RIC-01-0684

Mallet 26.5 cm / 10 ½" | 30 mm ø / 450 gms

- A: 20 .5cm / 8" | 25mm ø / 120 gms
- B: 21cm / 8 ¼" | 30mm ø / 180 gms
- C: 21.5cm / 8 ½" | 35mm ø / 260 gms



RIC-01-0685

Doyen Mallet

ELEVATORS SPINAL – S/S & FIBRE



RIC-01-0686
Herbert Mallet 19 cm / 7 ½"
For ulnar head prosthesis



RIC-01-0687
Collin Mallet 20 cm / 8"
23 mm ø / 220 gms



RIC-01-0688
Mallet 26.5 cm / 10 ½"
50 mm ø / 900 gms



RIC-01-0689
Vickers Mallet 19 cm / 7 ½"
25 mm ø / 300 gms



RIC-01-0690
Kirk Mallet 20cm / 8"
Head Dia 38mm / Weight: 1 lb. 4 oz. (570 grams)

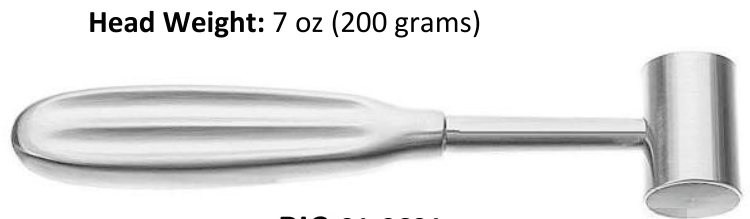

Head Weight: 7 oz (200 grams)
RIC-01-0691
Gerzog Mallet 19 cm / 7 ½"
Head Dia 25mm / Weight 10 oz (285 grams)

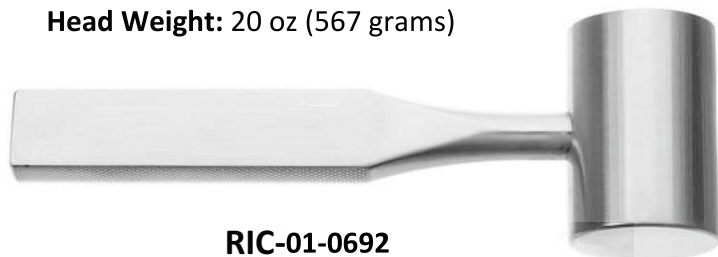

Head Weight: 20 oz (567 grams)
RIC-01-0692
Heath Mallet 19 cm / 7 ½"
Head Dia 40mm / Weight 2 lbs. (907gm)



Head Weight: 20 oz (567 grams)
RIC-01-0693
Heath Mallet, SS 18 cm / 7" Solid Frame Handle
Head Dia 40mm / Weight 36 oz. (1020gm)

ELEVATORS SPINAL – S/S & FIBRE



RIC-01-0694

All Fibre Mallet 24 cm / 9 ½"
Head Dia 80X60mm Weight 14oz. (397gm)



Fibre Handle

RIC-01-0695

Cloward Mallet 19cm / 7 ½"
Head Dia 20mm / Weight 8oz. (227gm)



RIC-01-0696

Hajek Mallet 20 cm / 8"
Head Dia 27mm / Weight: 7 oz. (198gm)



Fibre Handle

RIC-01-0697

Narrow Tip Mallet 20cm / 8"
Head Dia 7mm Weight 6oz. (170gm)

B: Head Dia 35mm Weight 11b 40 oz. (570gm)
C: Head Dia 40mm Weight 11b 90 oz. (708gm)



RIC-01-0698

Fibre Handle Mallet 23cm / 9"
A: Head Dia 30mm / Weight 12 oz. (340gm)

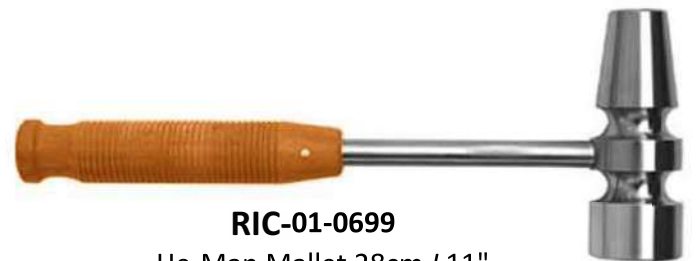

RIC-01-0699

He-Man Mallet 28cm / 11"
Head Dia 38mm / 24mm / Weight 21b (906gm)

MENISCUS – TENDON – CARTILAGE INSTRUMENTS

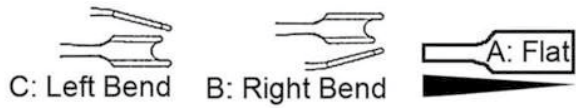

RIC-01-0700
Smillie Meniscus Knife 18 cm / 7"



RIC-01-0701
Meniscus Knife 18 cm / 7"

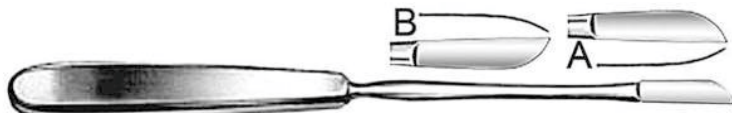

RIC-01-0702
Neff Meniscus Knife 22 cm / 8 3/4"



RIC-01-0703
Salenius Meniscus Knife 21 cm / 8 1/4" A: Right / B: Left



RIC-01-0704
Bunnell Tendon Stripper 15 cm / 6"



RIC-01-0705
Fischer Tendon Stripper 31 cm / 12 1/4" Blunt



RIC-01-0706
Tendon Passing Instrument 33.5 cm / 13 1/4"



RIC-01-0707
Fischer Tendon Stripper 31 cm / 12 1/4" Blunt

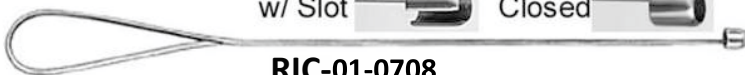

RIC-01-0708
Tendon Stripper 3 / 4 / 5 / 6mm
A: 28.5 cm / 11 1/4" B: 60 cm / 24"



RIC-01-0709
Bunnell Tendon Passer 23 cm / 9" Malleable



RIC-01-0710
Downing Cartilage Knife 25 cm / 10"
Concave Edge Cvd Blade w/ Guards



RIC-01-0711
Lowe Breck Cartilage Knife 25cm/10" STR Edge-Cvd Blade w / Guards



RIC-01-0712
Tendon Stripper 40 cm / 16" Fibre Handle

TENDON INSTRUMENTS



RIC-01-0713
Martin Cartilage Scissors 20cm / 8"

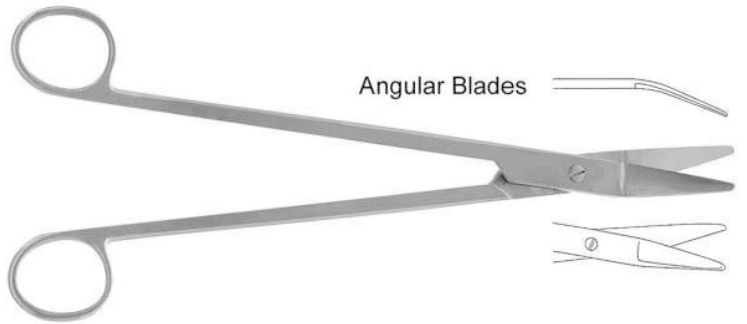

RIC-01-0714
Mueller Capsule Scissors 24 cm / 9 1/2"

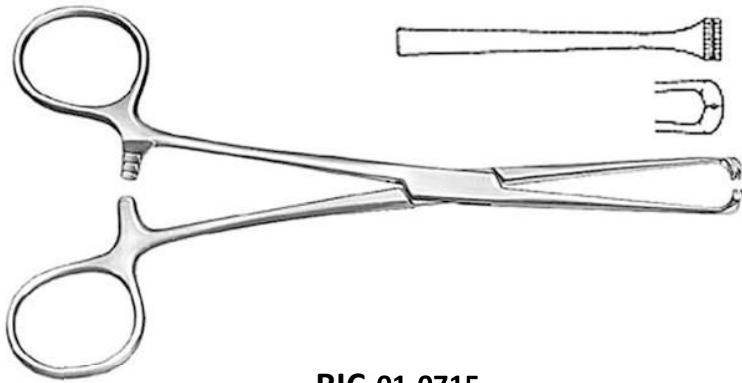

RIC-01-0715
Steinmann Tendon Holding Forceps 16 cm / 6 1/4"

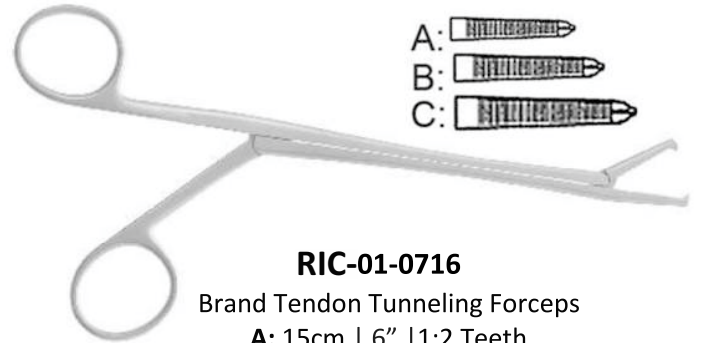

RIC-01-0716
Brand Tendon Tunneling Forceps
A: 15cm | 6" | 1:2 Teeth
B: 19cm | 7 1/2" | 1:2 Teeth
C: 24.5cm | 9 3/4" | 1:2 Teeth

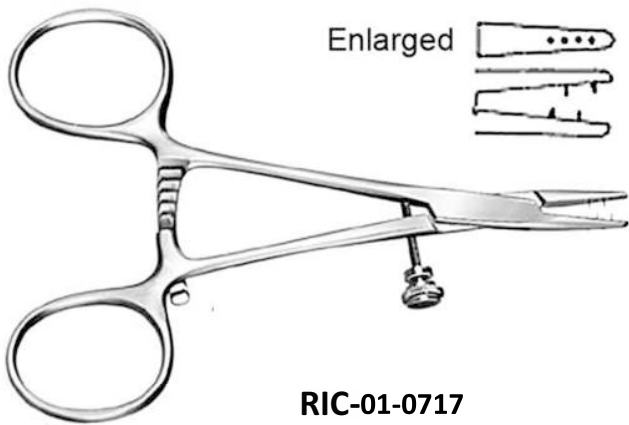

RIC-01-0717
Tendon Holding Forceps
11.5cm / 4 1/2"

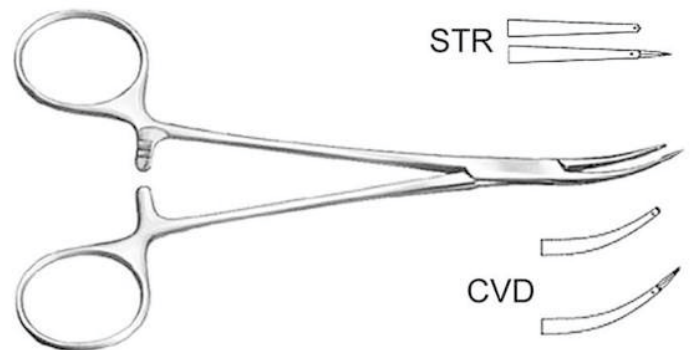

RIC-01-0718
Tendon Interlacing Forceps
15.5 cm / 6" Pointed

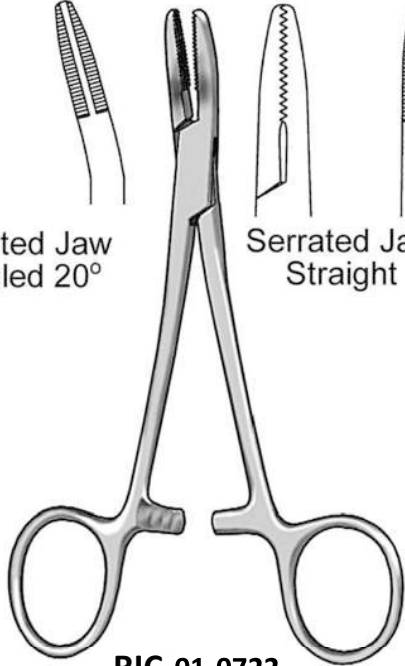
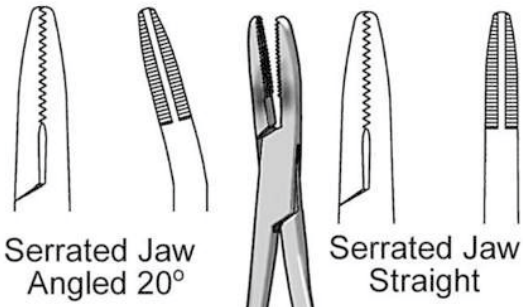

RIC-01-0722
Meniscus Clamp
13.5 cm / 5 3/8" 1X2 teeth

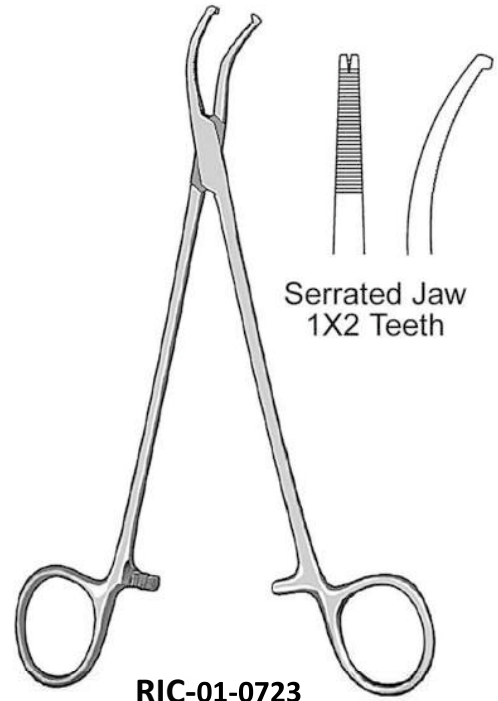

RIC-01-0723
Preston Ligamentum Flavum Forceps
(Meniscus) 18.5 cm / 7 1/4"



Straight

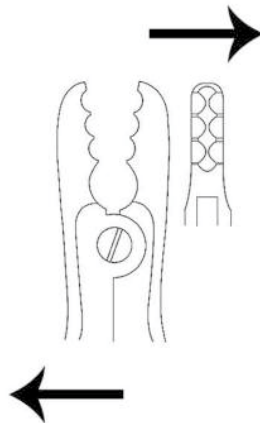

RIC-01-0724
Ortho Grasper 21 cm / 8 1/2"
7 X 20 MM Bite



Angled

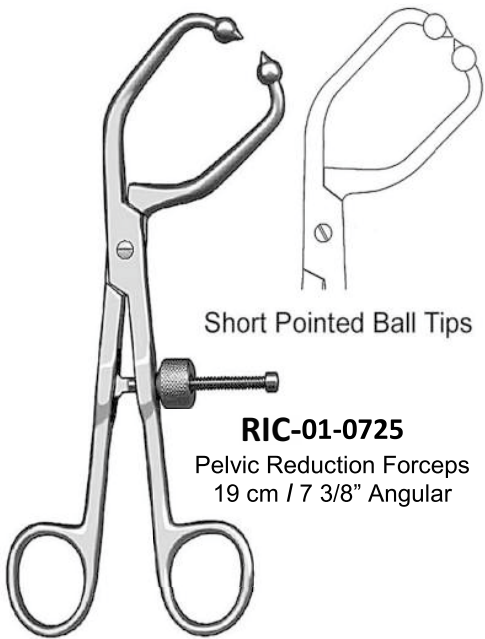

Short Pointed Ball Tips

RIC-01-0725
Pelvic Reduction Forceps
19 cm / 7 3/8" Angular

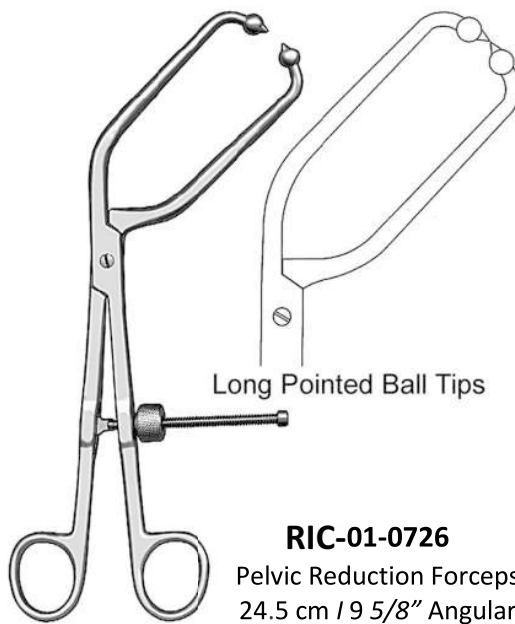

Long Pointed Ball Tips

RIC-01-0726
Pelvic Reduction Forceps
24.5 cm / 9 5/8" Angular

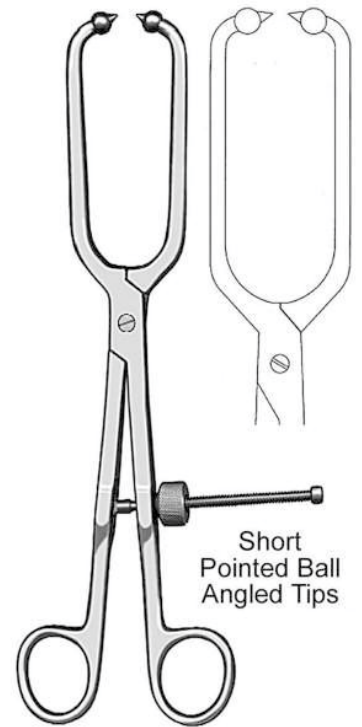

Short Pointed Ball Angled Tips

RIC-01-0727
Pelvic Reduction Forceps
25 cm / 10"



Long Pointed Ball Tips

RIC-01-0728
Pelvic Reduction Forceps
Available in 2 Sizes
A: 24 cm / 9 1/2"
B: 41cm / 16"

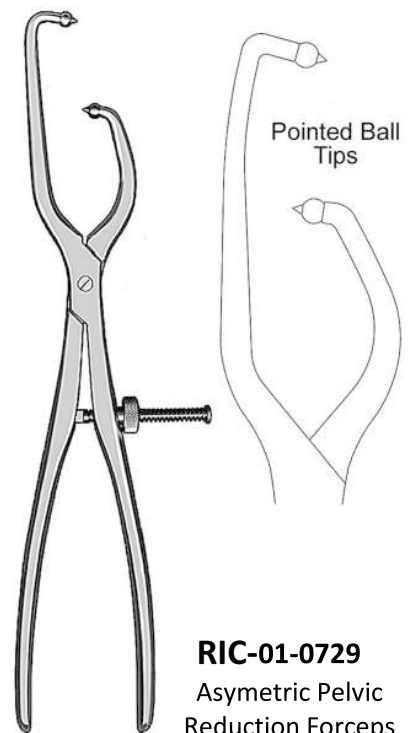

Pointed Ball Tips

RIC-01-0729
Asymmetric Pelvic Reduction Forceps
41 cm / 16"

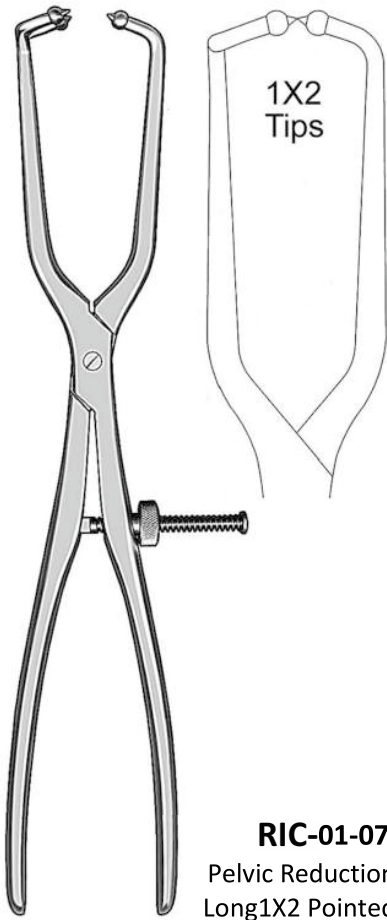

RIC-01-0730
Pelvic Reduction Forceps
Long 1X2 Pointed Ball Tips
41 cm / 16"

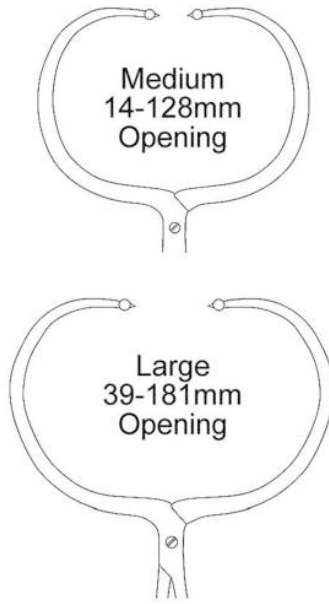

RIC-01-0731
Periarticular Reduction Forceps
Straight / Pointed Ball Tips
38 cm / 15"



RIC-01-0732
Pelvic Reduction Forceps
Adjustable Jaws for Screws
A: 25 cm / 10" B: 33 cm / 13"

BONE HOLDING FORCEPS

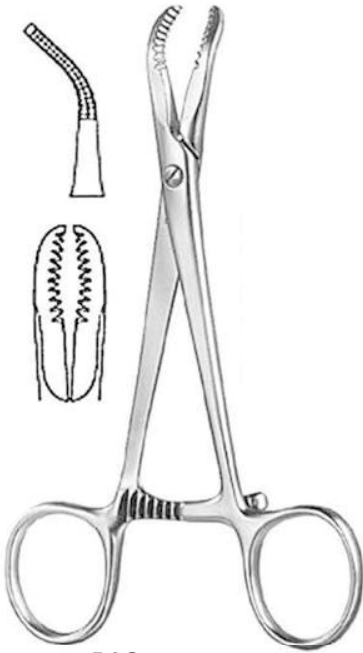

RIC-01-0733

Bone Holding Forceps
14 cm / 5 1/2"

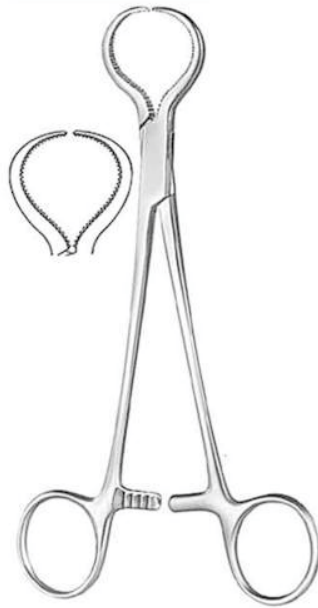

RIC-01-0734

Lewin Bone Holding Forceps
18.5 cm / 7 1/4"



RIC-01-0735

Bone Holding Forceps
14 cm / 5 1/2" Delicate



RIC-01-0736

Frosch Bone Holding Forceps 18 cm / 7"



RIC-01-0737

Bone Holding Forceps 20 cm / 8"



11-01-0738

Semb Bone Holding Forceps 19 cm / 7 1/2"



RIC-01-0739

Lengenbeck Bone Holding Forceps 21 cm / 8 1/4"

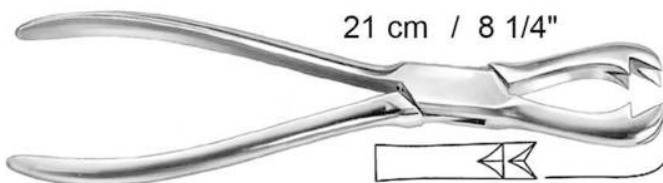

RIC-01-0740

Fergusson Bone Holding Forceps Heavy pattern



RIC-01-0741 A: 23 cm / 9" B: 26 cm / 10 1/4"

Farabeuf Bone Holding Forceps

BONE HOLDING FORCEPS



RIC-01-0742

Kern Bone Holding Forceps

A: 17 cm / 6 ¾"

B: 21 cm / 8 ¼"

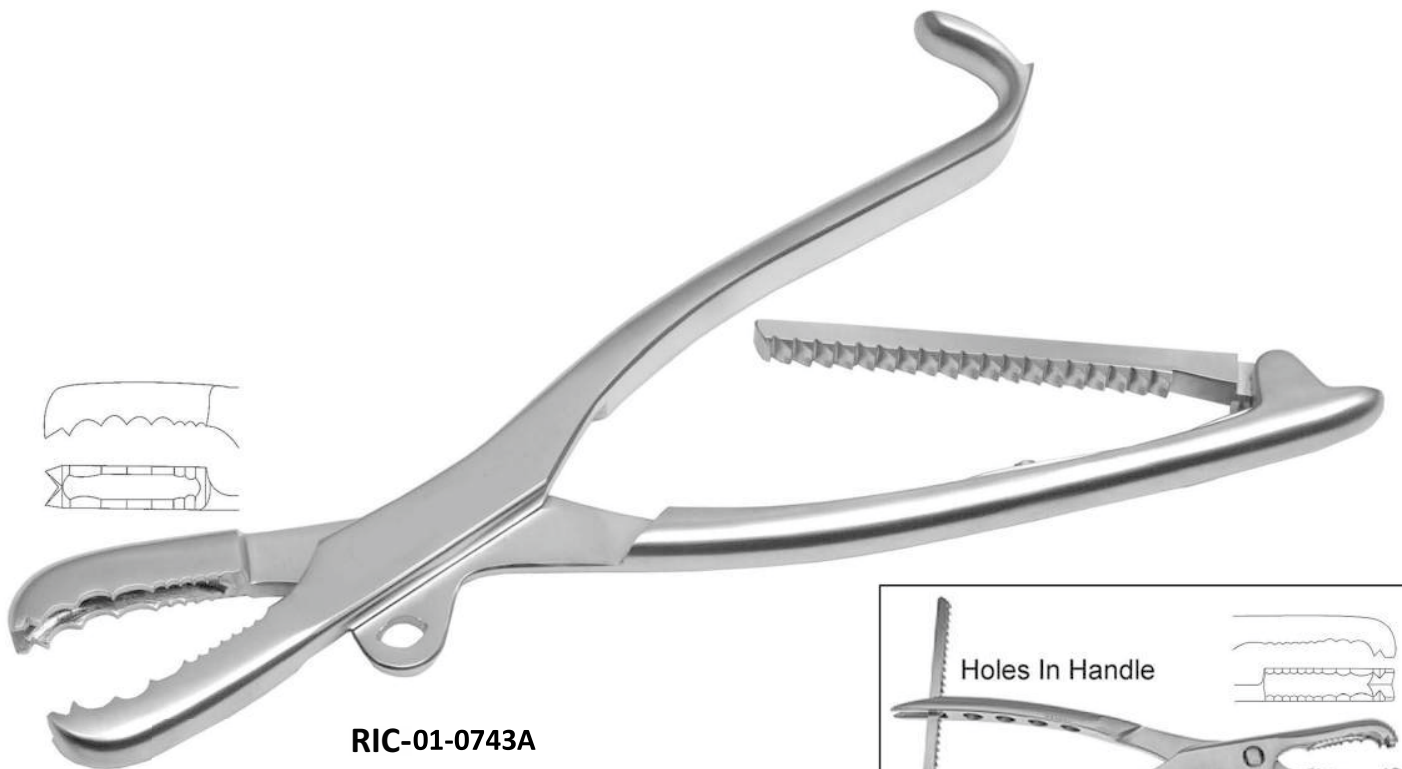

RIC-01-0743A

Farabeuf Lambotte Bone Holding Forceps

A: 23 cm / 9" | **B:** 26 cm / 10"

Adjustable / with Ratchet



Holes In Handle

RIC-01-0743B

BONE HOLDING FORCEPS



RIC-01-0744

Lambotte Bone Holding Forceps
w / Swivel Head, Adjustable Jaw

A: 22 cm | 8 ¾" | B: 27 cm | 10 ¾" | C: 30 cm | 11 ¾"



RIC-01-0745

Ulrich Bone Holding Forceps
w / Thread Fixation 19 cm / 7 ¼"

RIC-01-0746

Ulrich Bone Holding Forceps
w / Thread Fixation

A: 23 cm | 9" | B: 25 cm | 9 ¾" | C: 28 cm | 11"

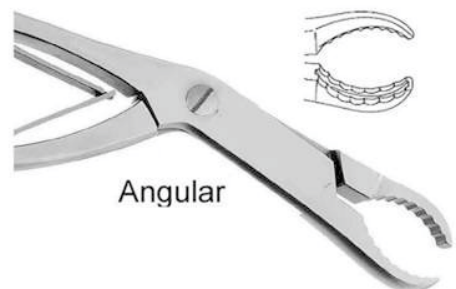

Angular

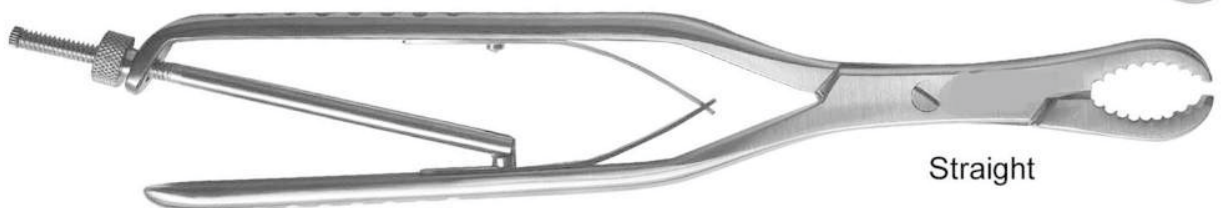

Straight

BONE HOLDING FORCEPS

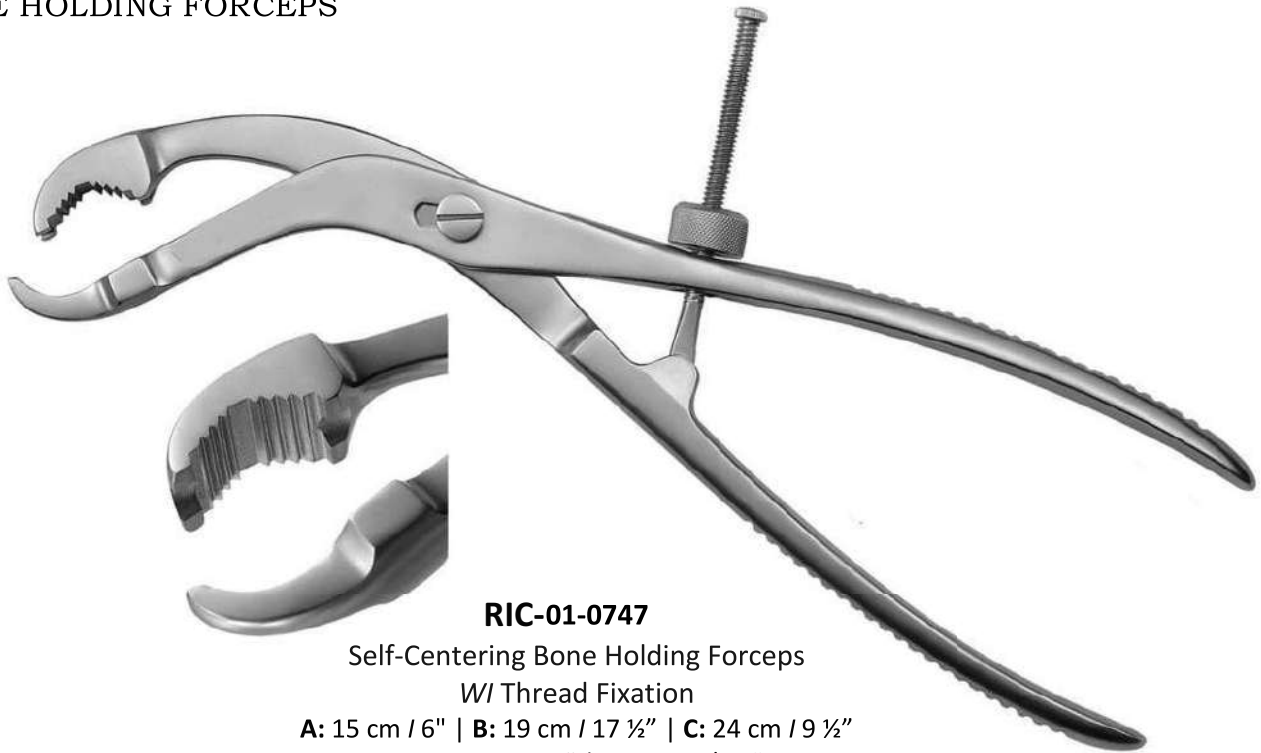

RIC-01-0747
 Self-Centering Bone Holding Forceps
 W/ Thread Fixation
 A: 15 cm / 6" | B: 19 cm / 17 ½" | C: 24 cm / 9 ½"
 D: 26 cm / 10 ¼" | E: 28 cm / 11"



RIC-01-0748
 Lane Bone Holding Forceps w / Ratchet
 A: 33 cm / 13"
 B: 45 cm / 17 ¾"

RIC-01-0749
 Without Ratchet

BONE HOLDING FORCEPS



RIC-01-0750

Hey Groves Bone Holding Forceps

A: 20 cm / 8" | B: 25 cm / 10" | C: 30 cm / 12"



RIC-01-0751

Verbrugge Bone Holding Forceps

A: 17.5 cm / 7" | B: 25 cm / 9 ¾"
C: 26 cm / 10 ¼" | D: 27 cm / 10 ¾"



RIC-01-0752

Smooth Jaws Bone Holding Forceps

23 cm / 9"

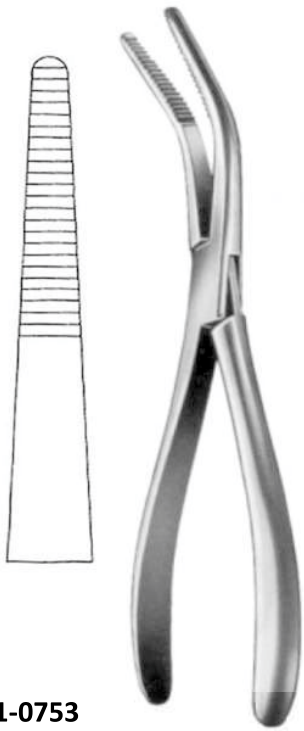

RIC-01-0753
Van Buren Bone Holding Forceps
21.5 cm / 8 1/2"

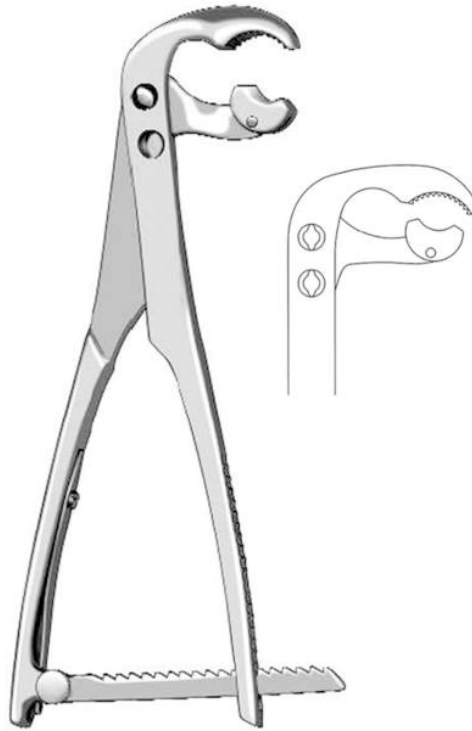

RIC-01-0754
Angled Bone Holding Forceps 23 cm / 9"



RIC-01-0755
Bishop Bone Holding Forceps 23 cm / 9"



RIC-01-0756
Bone Holding Forceps
A: 17cm 6 3/4" 0.9mm
B: 13cm 5 1/4" 1.6mm

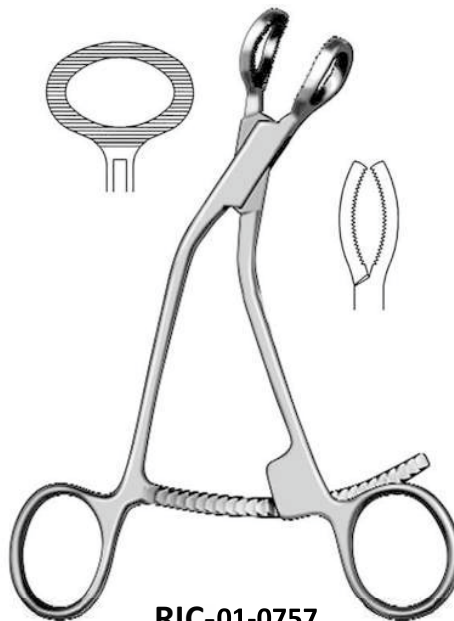

RIC-01-0757
Bishop Bone Holding Forceps
23 cm / 9"



RIC-01-0758
Patella Forceps 18 cm / 7"

BONE HOLDING FORCEPS



RIC-01-0759

Hayton Williams Forward Traction Forceps
Broad Tips 23 cm / 9"



RIC-01-0760

Fibula Bone Holding Forceps
21 cm / 8 ½"

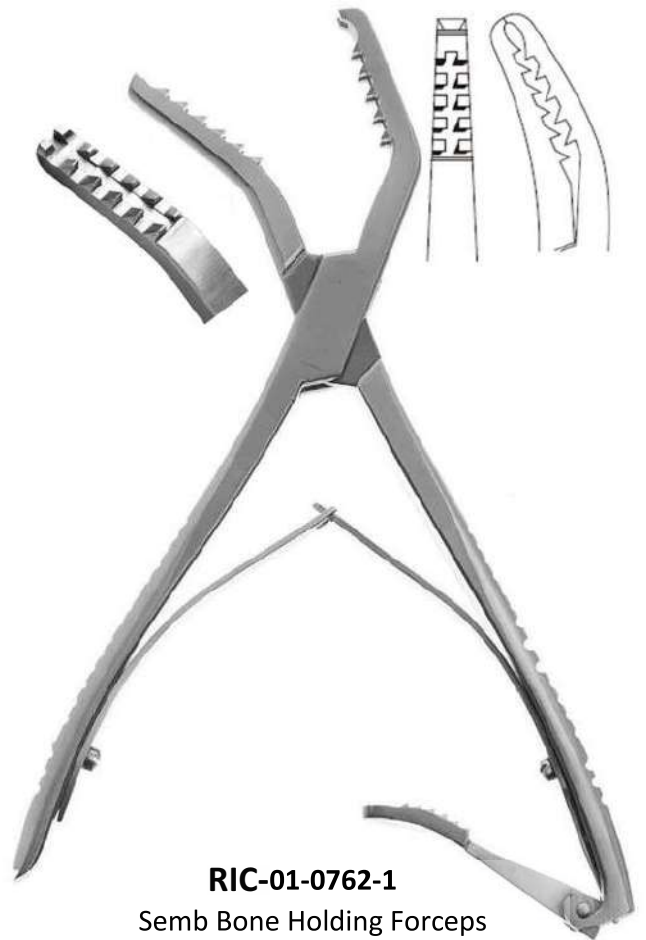

RIC-01-0762-1

Semb Bone Holding Forceps
Curved Sideward
21 cm / 8 ½"



RIC-01-0761

Bone Holding Forceps
w/ Thread Fixation
15 cm / 6"



Small

Large

RIC-01-0762-2

Bargo Bone Holding Forceps 15 cm / 6"

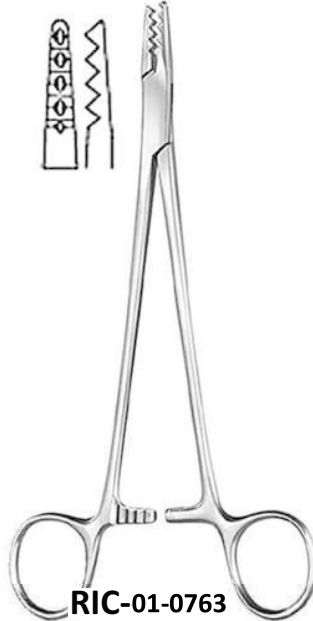

RIC-01-0763

Martin Cartilage Seizing Forceps
18.5 cm / 7 1/4"

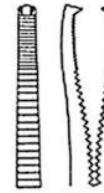
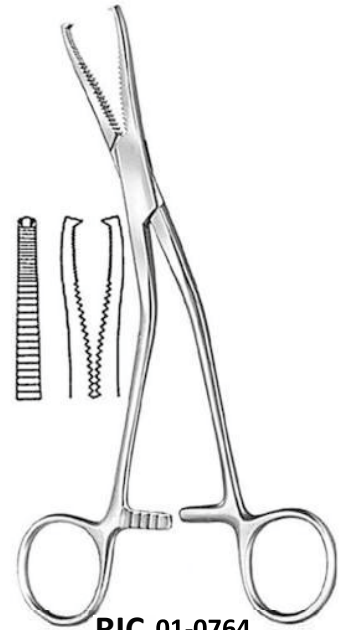

RIC-01-0764

Dingmann Cartilage Seizing Forceps
18.5 cm / 7 1/4"



RIC-01-0765

Reposition Forceps
13.5 cm / 5 1/4" Long ratchet pointed



RIC-01-0766

Reposition Forceps
15 cm / 6" Long Ratchet Pointed

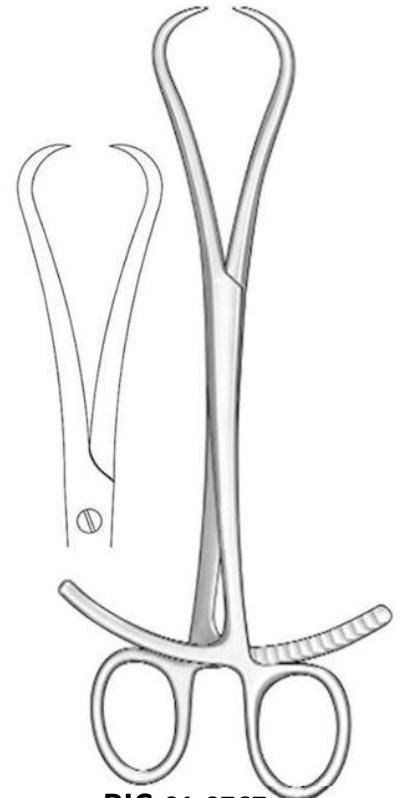

RIC-01-0767

Walton Bone Reduction Forceps
20.5 cm / 8" | 2" Double Ratchet
Opening 9-100mm

REPOSITION – CARTILAGE FORCEPS

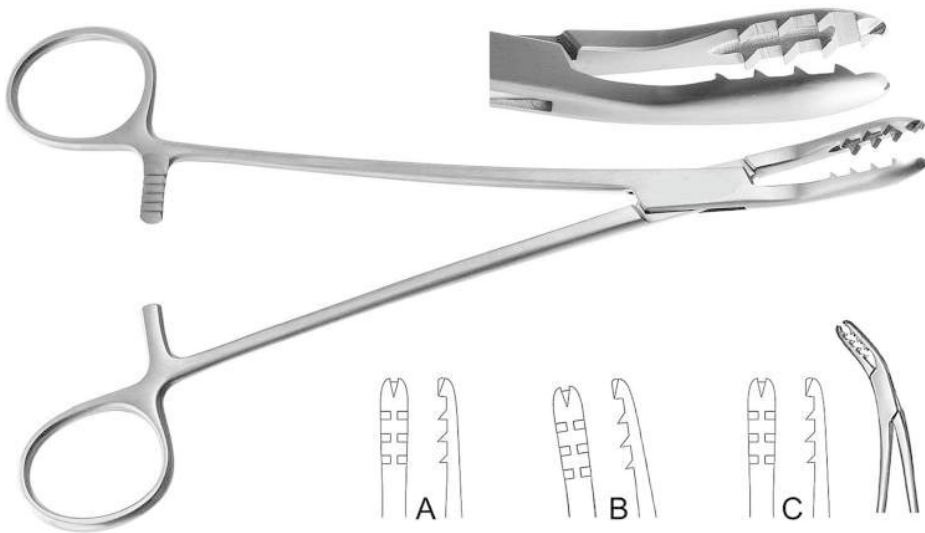

RIC-01-0768

Cartilage Seizing Forceps

A: Straight | B: Upward Cvd | C: Sideward Cvd

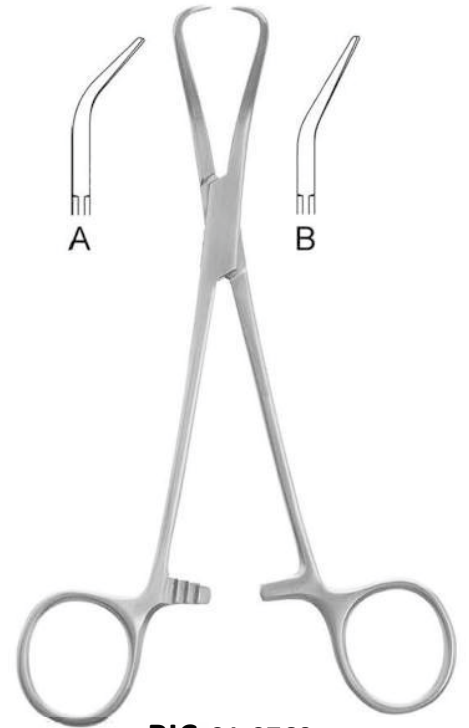

RIC-01-0769

Glenoid Perforating Forceps 17cm / 6 ½"

A: Strong Cvd | B: Slight Cvd



RIC-01-0770

Bone Reposition Forceps
w / Thread Fixations Screw

A: 17 cm / 6 ¾"

B: 24 cm / 9 ½"



RIC-01-0771

Reill Bone Reduction Forcep
17.5 cm / 7"

BONE CUTTING FORCEPS

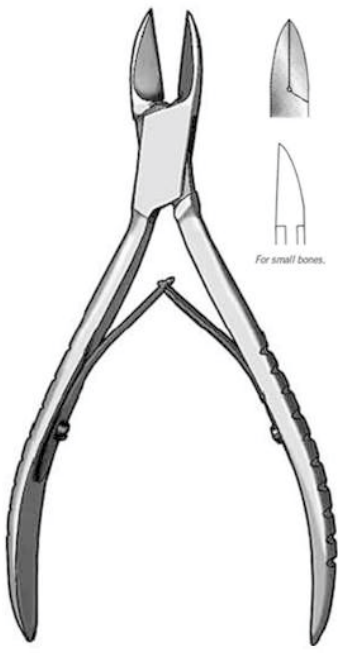

For small bones.

RIC-01-0772

Littauer Bone Cutting Forceps
15 cm / 6"



RIC-01-0773

Marwalder Bone Nipper
18.5 cm / 7 1/4"



RIC-01-0774

Cottle Kazanjian Bone Cutting
Forceps 18.5 cm / 7 1/4"

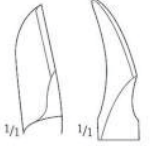
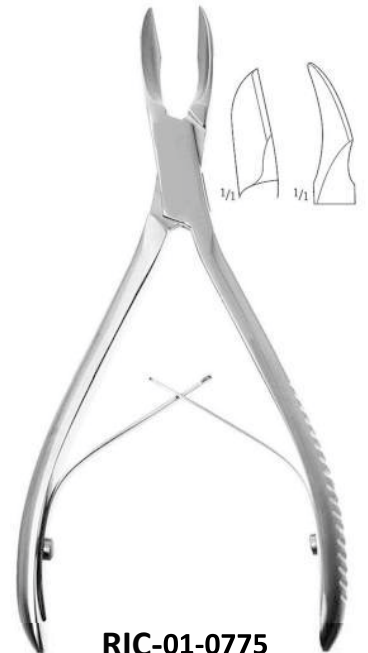

RIC-01-0775

Cleveland Bone Cutting Forceps
A: 14.5 cm / 5 3/4"
B: 17 cm / 6 3/4"

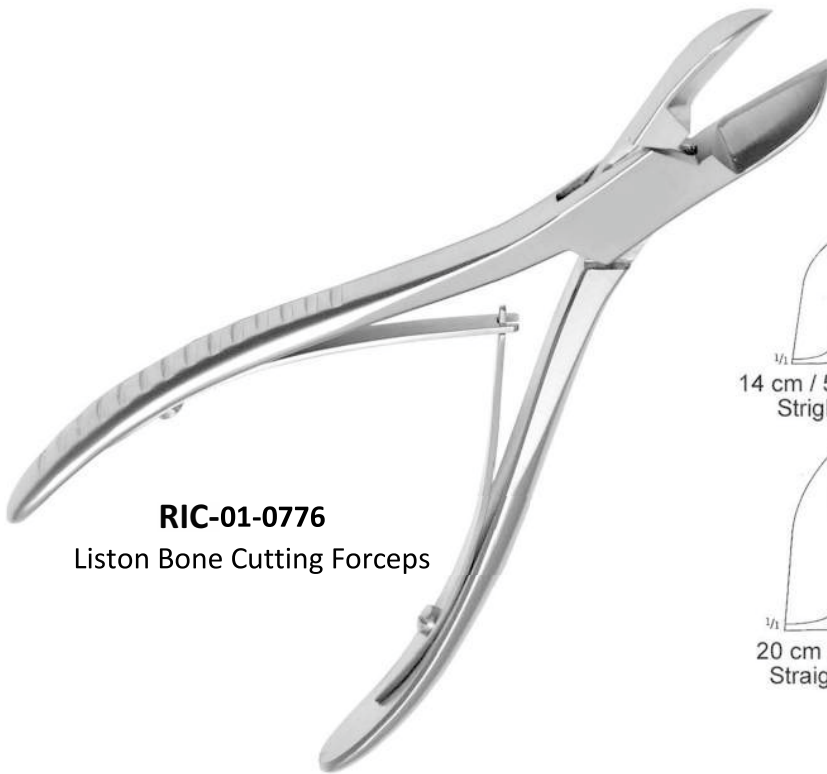

RIC-01-0776

Liston Bone Cutting Forceps

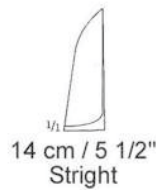

14 cm / 5 1/2"
Straight



14 cm / 5 1/2"
Curved

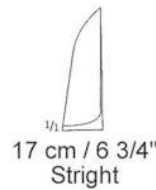

17 cm / 6 3/4"
Straight



17 cm / 6 3/4"
Curved

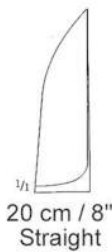

20 cm / 8"
Straight



20 cm / 8"
Curved

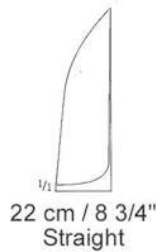

22 cm / 8 3/4"
Straight

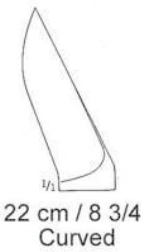

22 cm / 8 3/4"
Curved

BONE CUTTING FORCEPS

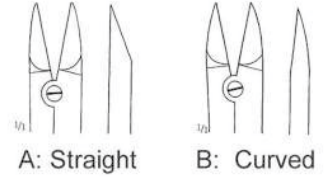

RIC-01-0777

Kleinert-Kutz / Bohler Bone Cutting Forceps 14.5 cm / 5 ¾"

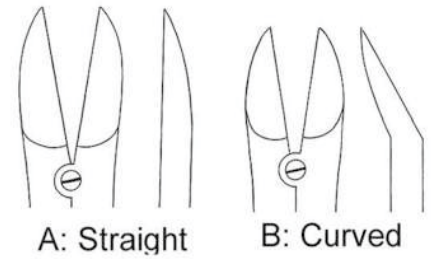

RIC-01-0778

Ruskin Liston Bone Cutting Forceps 18 cm / 7"

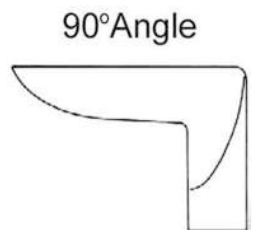

RIC-01-0779

Stille-Liston Bone Cutting Forceps 26 cm / 10 ¼"

BONE CUTTING FORCEPS

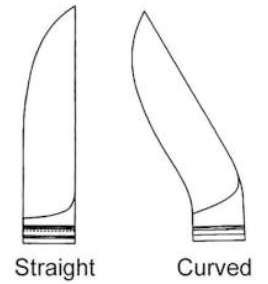

RIC-01-0780

Stille-Liston Bone Cutting Forceps
A: 23 cm / 9" | B: 27.5 cm / 10 3/4"



RIC-01-0781

Cleveland Bone Cutting Forceps
16 cm / 6 1/4"

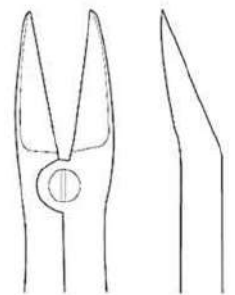
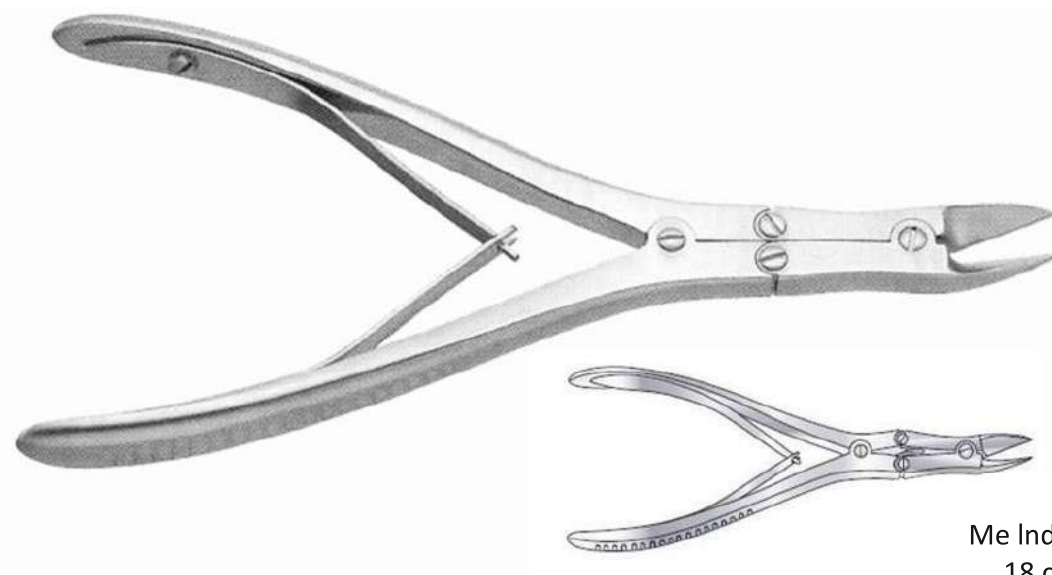

RIC-01-0782

Me Indoe Bone Cutting Forceps
18 cm / 7" Delicate Blades

BONE CUTTING FORCEPS

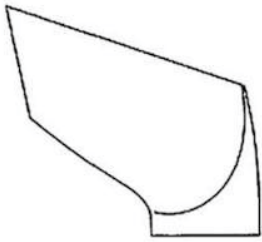

45° Angled

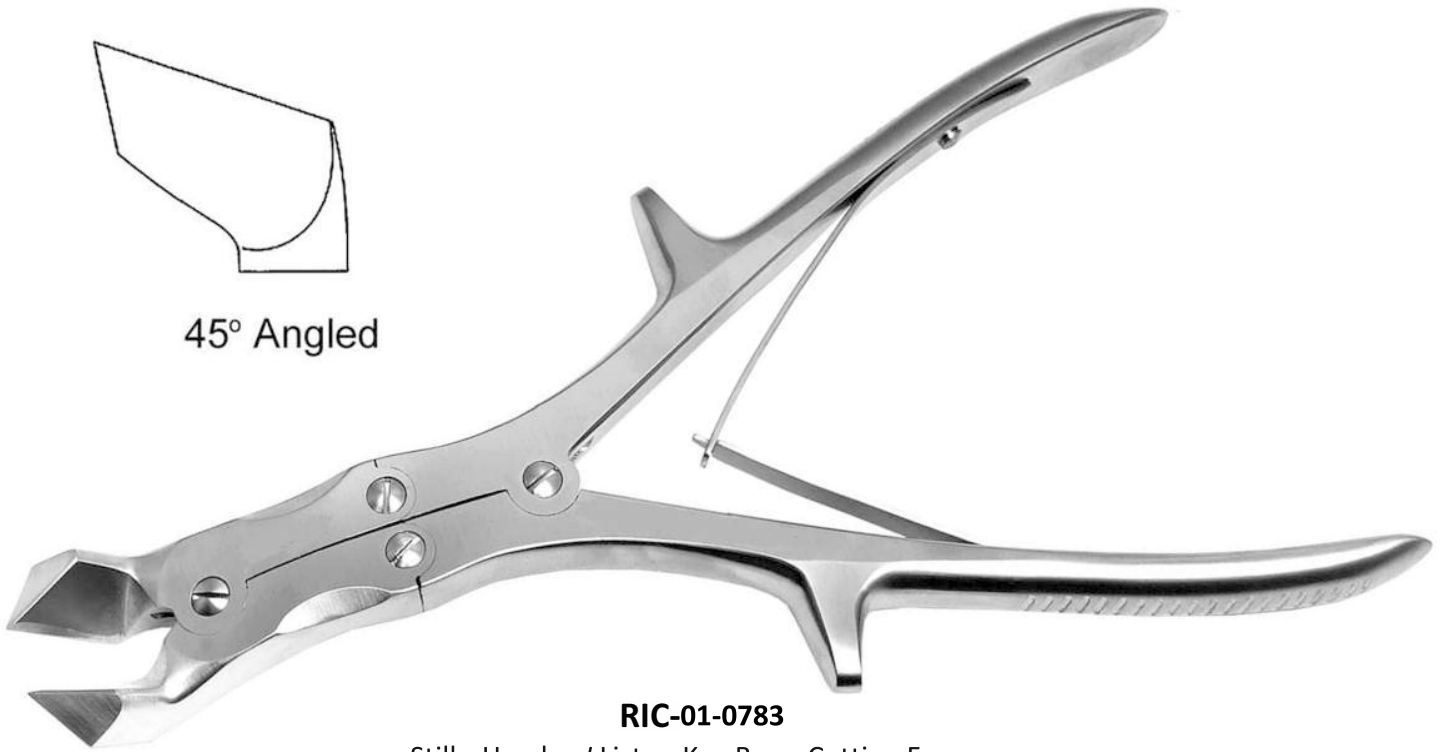

RIC-01-0783

Stille-Horsley / Liston Key Bone Cutting Forceps
25.5 cm / 10"

90° Angled

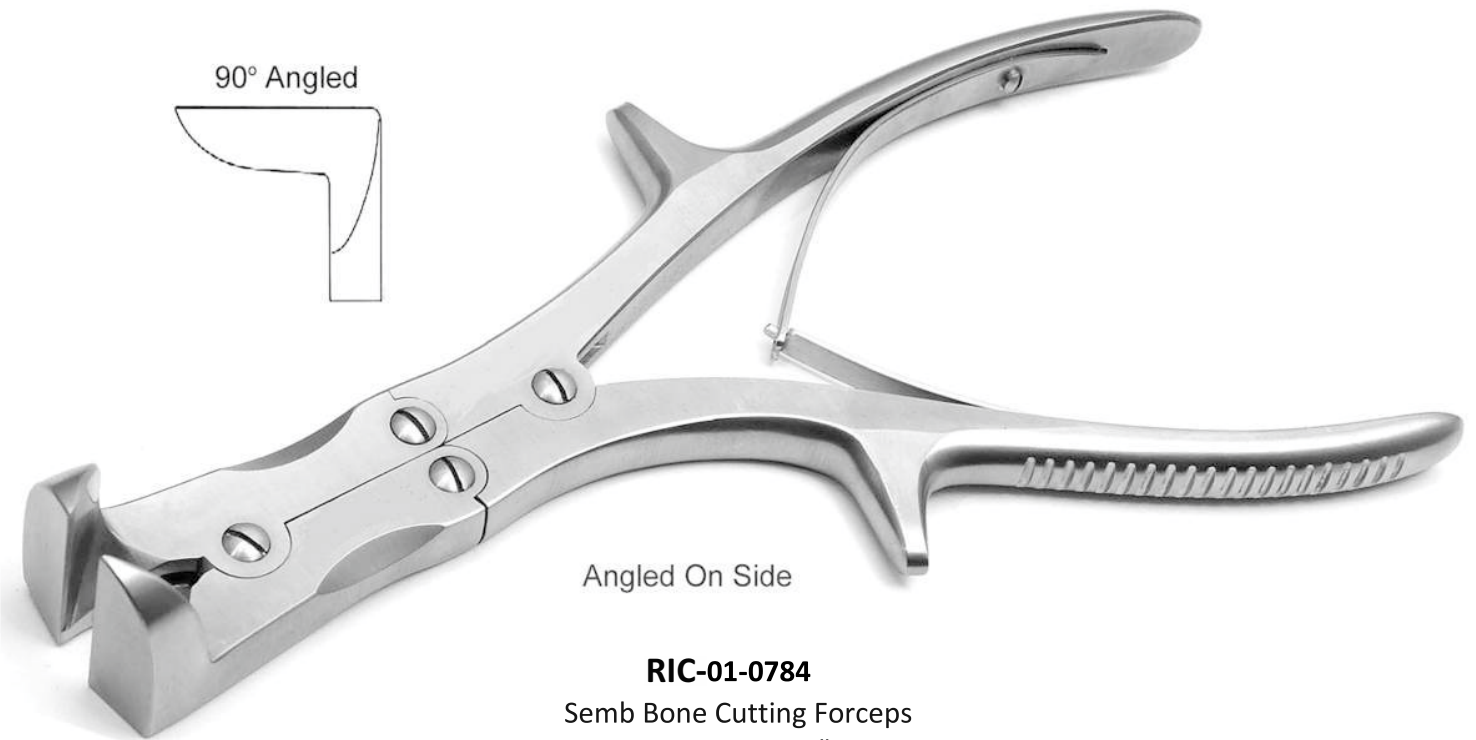
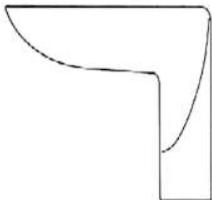

Angled On Side

RIC-01-0784

Semb Bone Cutting Forceps
24.5 cm / 9 3/4"

BONGE RONGEURS - NIBBLERS

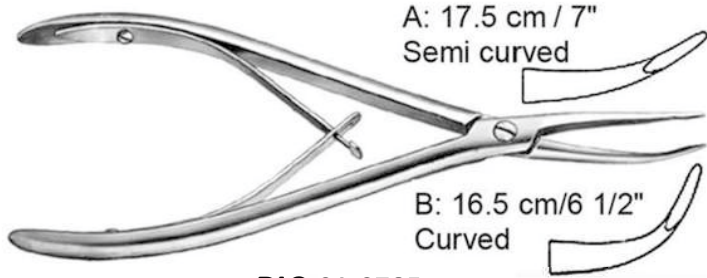

RIC-01-0785
Stellbrink Bone Rongeur



RIC-01-0786
Friedmann Bone Rongeur
A: 12.5 cm / 5" | B: 13.5 cm / 5 1/4"



RIC-01-0787
Friedmann Bone Rongeur
13.5 cm / 5 1/4"



RIC-01-0788
Cleveland Bone Rongeur
A: 13.5 cm / 5 1/4" | B: 16.5 cm / 6 1/2"



RIC-01-0789
Mead Bone Rongeur 16.5 cm / 6 1/2"

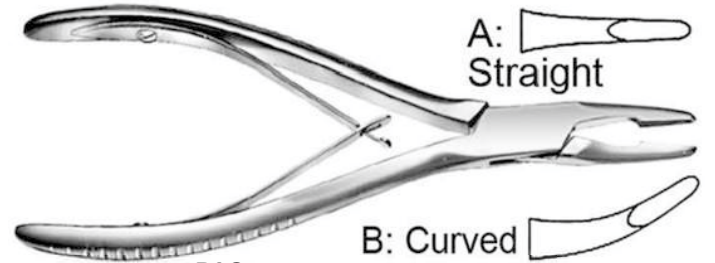

RIC-01-0790
Jansen Bone Rongeur 18 cm / 7"



RIC-01-0791-1
Luer Bone Rongeur 14.5 cm / 5 3/4"

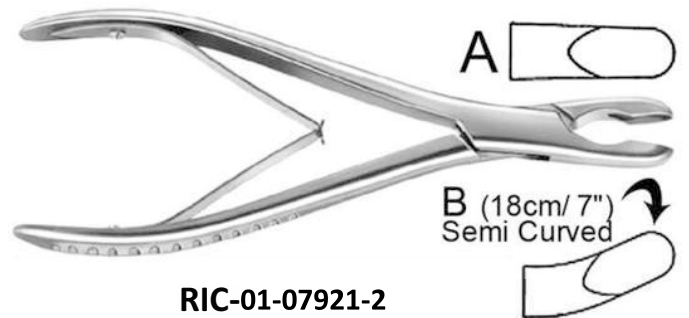

RIC-01-07921-2
Luer Bone Rongeur 18.5 cm / 7 1/4"

BONGE RONGEURS - NIBBLERS

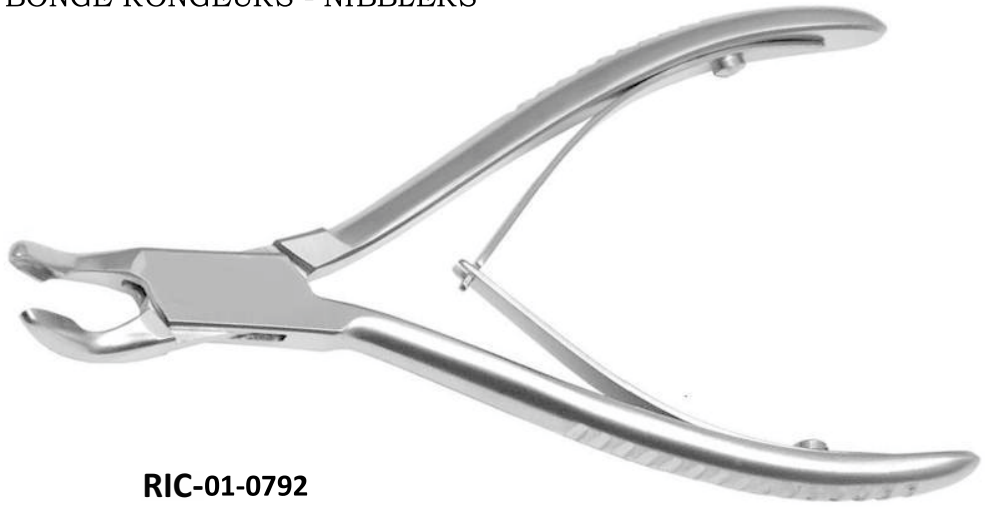
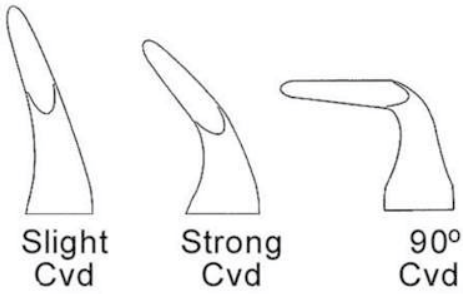

RIC-01-0792
Blumental Bone Rongeur 12.5 cm / 5"



RIC-01-0793
Hartmann Bone Rongeur 17.5 cm / 7"



RIC-01-0794
Jansen Bone Rongeur 19 cm / 7 1/2" Bayonet

BONGE RONGEURS - NIBBLERS



RIC-01-0795

Jansen Bone Rongeur Straight

A: 14 cm / 5 ½"

B: 17 cm / 6 ½"



RIC-01-0796

Jansen Bone Rongeur Delicate

14 cm / 5 ½"

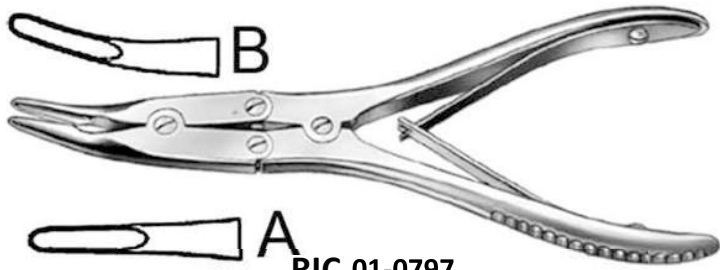

RIC-01-0797

Bohler Bone Rongeur 15.5 cm / 6"



RIC-01-0798

Beyer Bone Rongeur 18 cm / 7"



RIC-01-0799

Zaufai-Jansen Bone Rongeur 18 cm / 7"



RIC-01-0800

Mayfield Bone Rongeur 18 cm / 7"



RIC-01-0801

Marquard Bone Rongeur 20.5 cm / 8"



RIC-01-0802

Lempert Bone Rongeur 19 cm / 7 ½"

BONGE RONGEURS - NIBBLERS



RIC-01-0803
Stille Bone Rongeur
22.5 cm / 8 ¾"

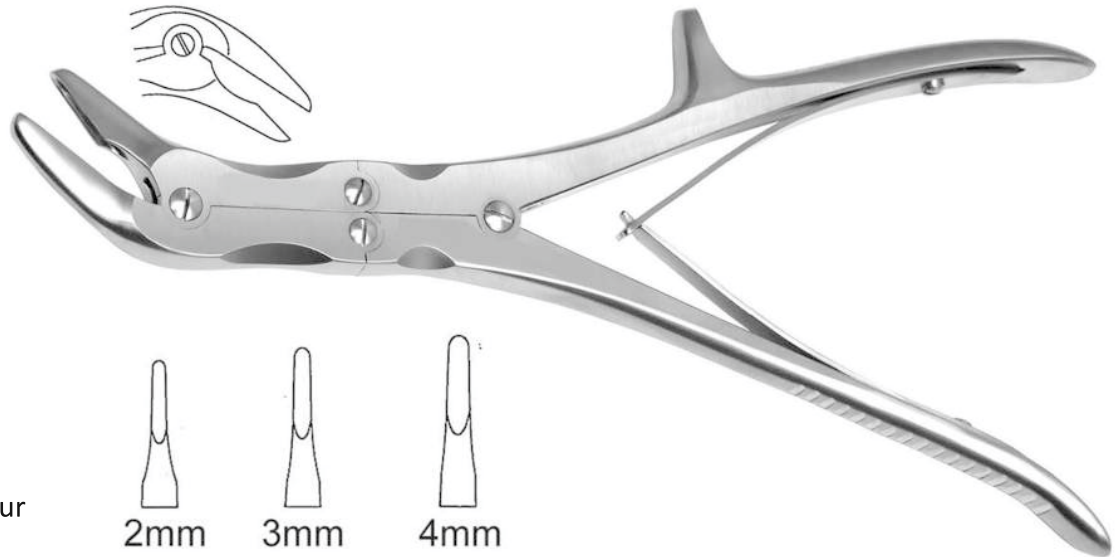

RIC-01-0804
Echlin Duckbill Bone Rongeur
22 cm / 8 ¾"

2mm 3mm 4mm



RIC-01-0805
Ruskin Bone Rongeur
18 cm / 7"

BONGE RONGEURS - NIBBLERS



RIC-01-0805

Ruskin Bone Rongeur
24 cm / 9 ½"

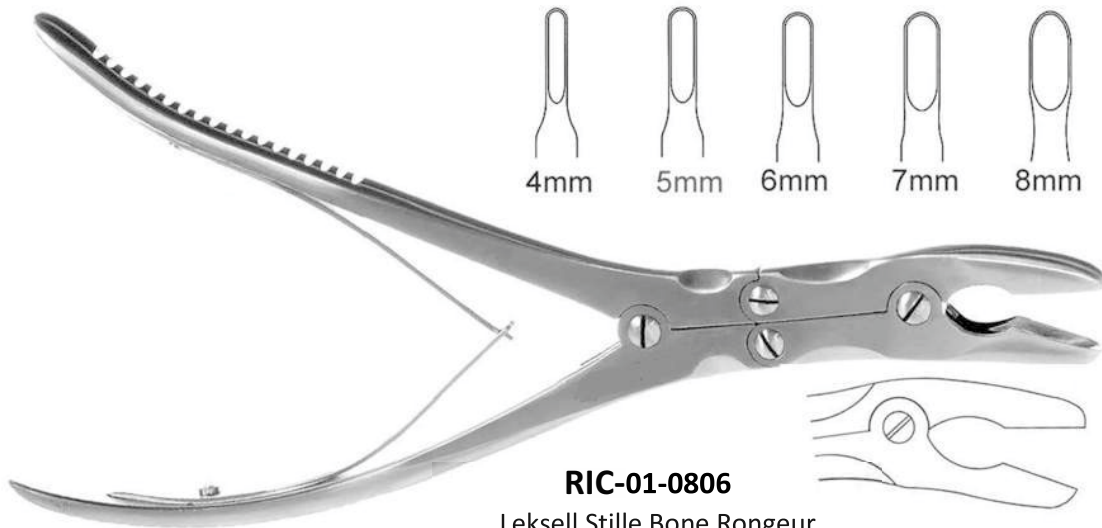

RIC-01-0806

Leksell Stille Bone Rongeur
24 cm / 9 ½"

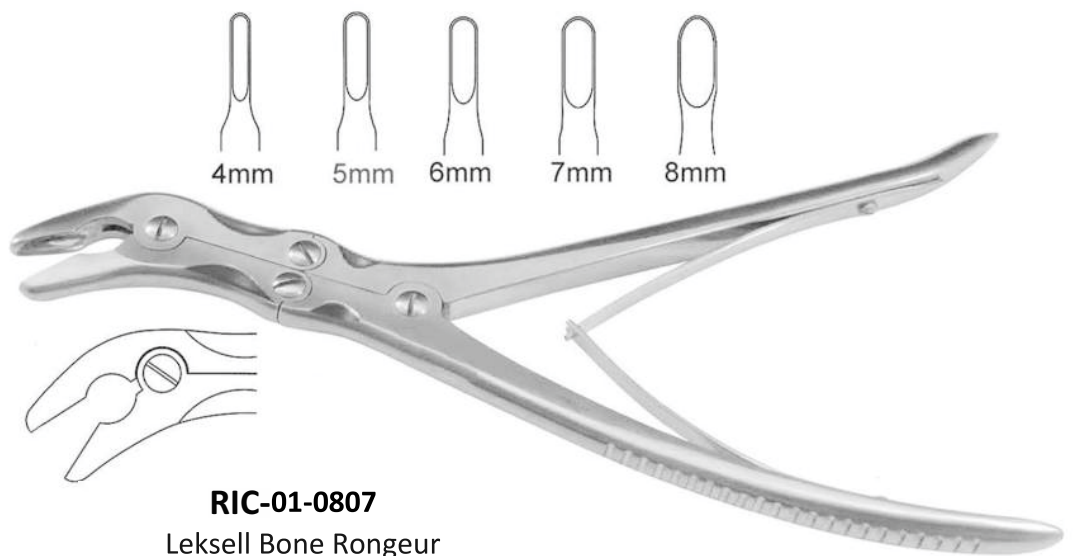

RIC-01-0807

Leksell Bone Rongeur
24 cm / 9 ½"



RIC-01-0808
Leksell Bone Rongeur
23 cm / 9"

- A: Straight
- B: Slight Curved
- C: Strong Curved
- D: Extra Strong Cvd

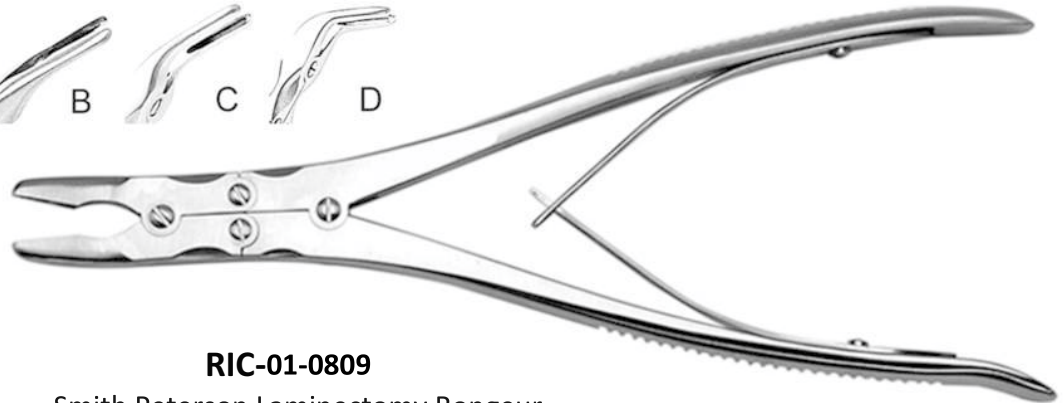

RIC-01-0809
Smith Peterson Laminectomy Rongeur
24 cm / 9 1/2"

Curved on Side
2 x 10mm
Delicate

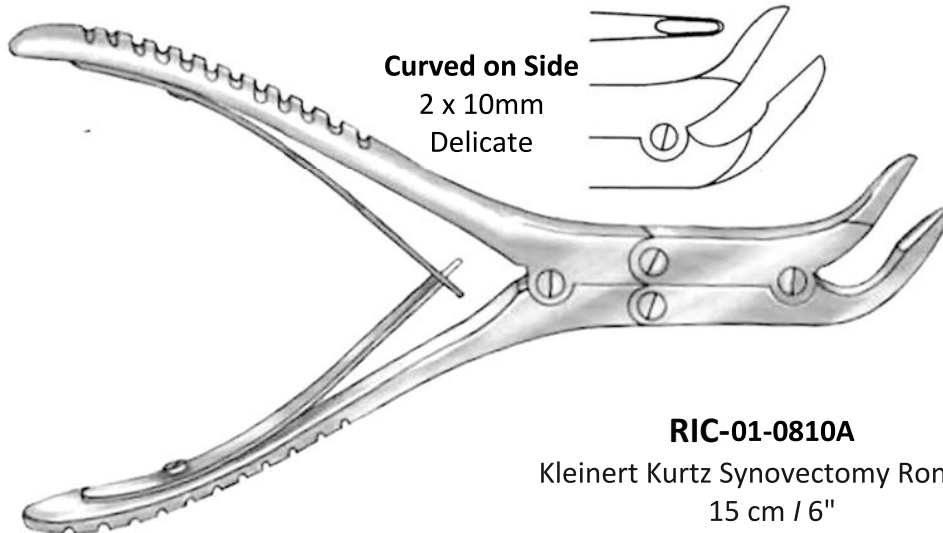
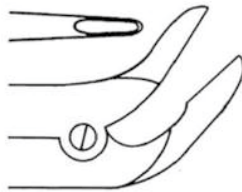

RIC-01-0810A
Kleinert Kurtz Synovectomy Rongeur
15 cm / 6"

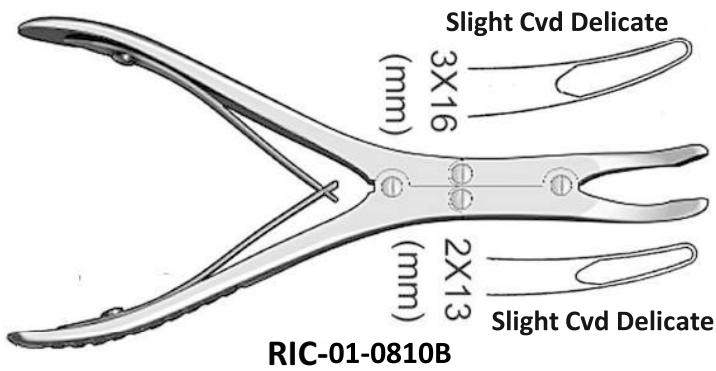

RIC-01-0810B
Kleinert Kurtz Synovectomy Rongeur 15 cm / 6"

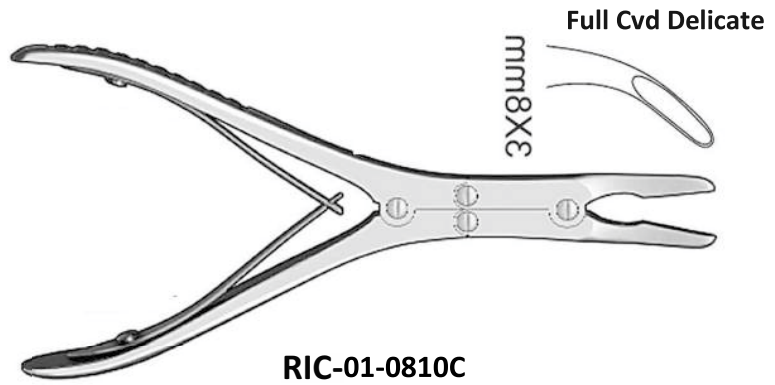

RIC-01-0810C
Kleinert Kurtz Synovectomy Rongeur 15 cm / 6"



RIC-01-0811
Semb Bone Rongeur 23.5 cm / 9 1/4"



RIC-01-0812
Stille Ruskin Bone Rongeur
23.5 cm / 9 1/4"

BONGE RONGEURS - NIBBLERS

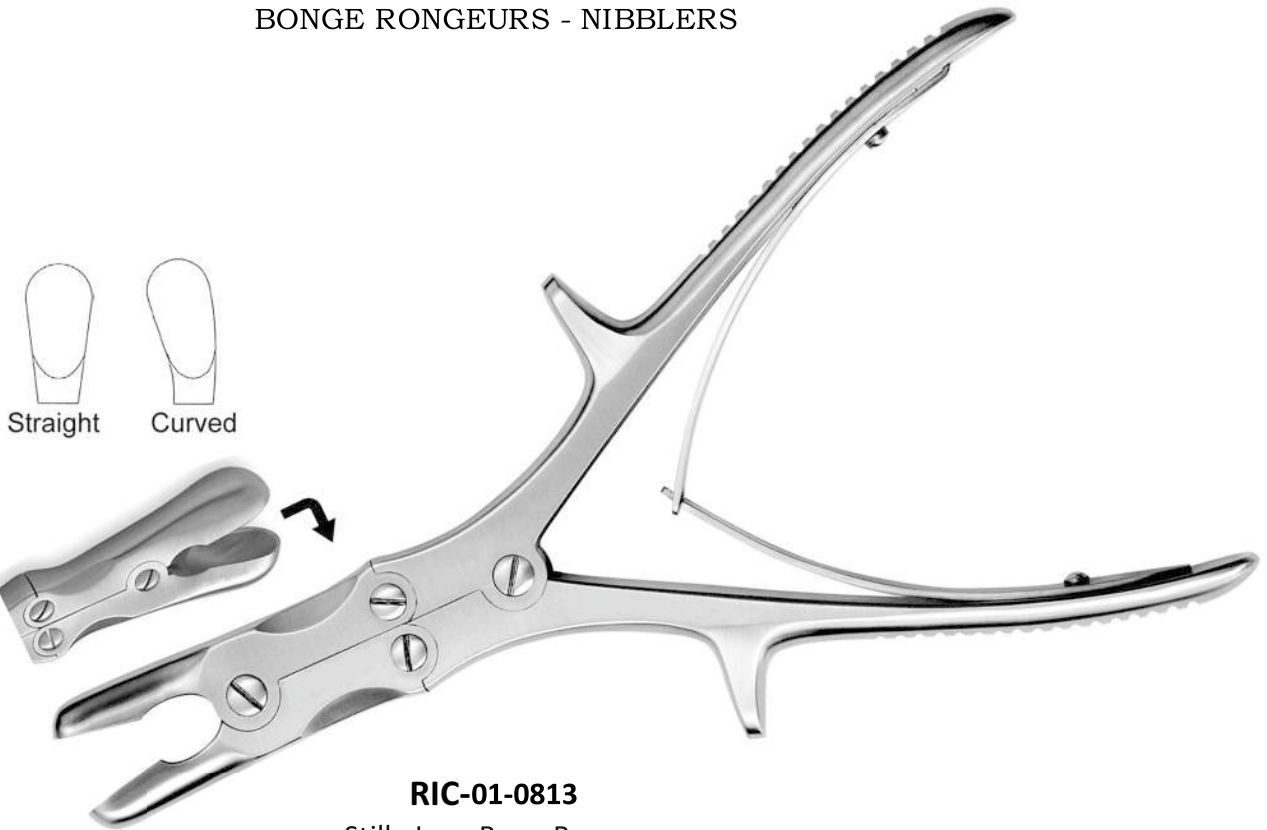

RIC-01-0813

Stille Luer Bone Rongeur
26.5 cm / 10 1/2"

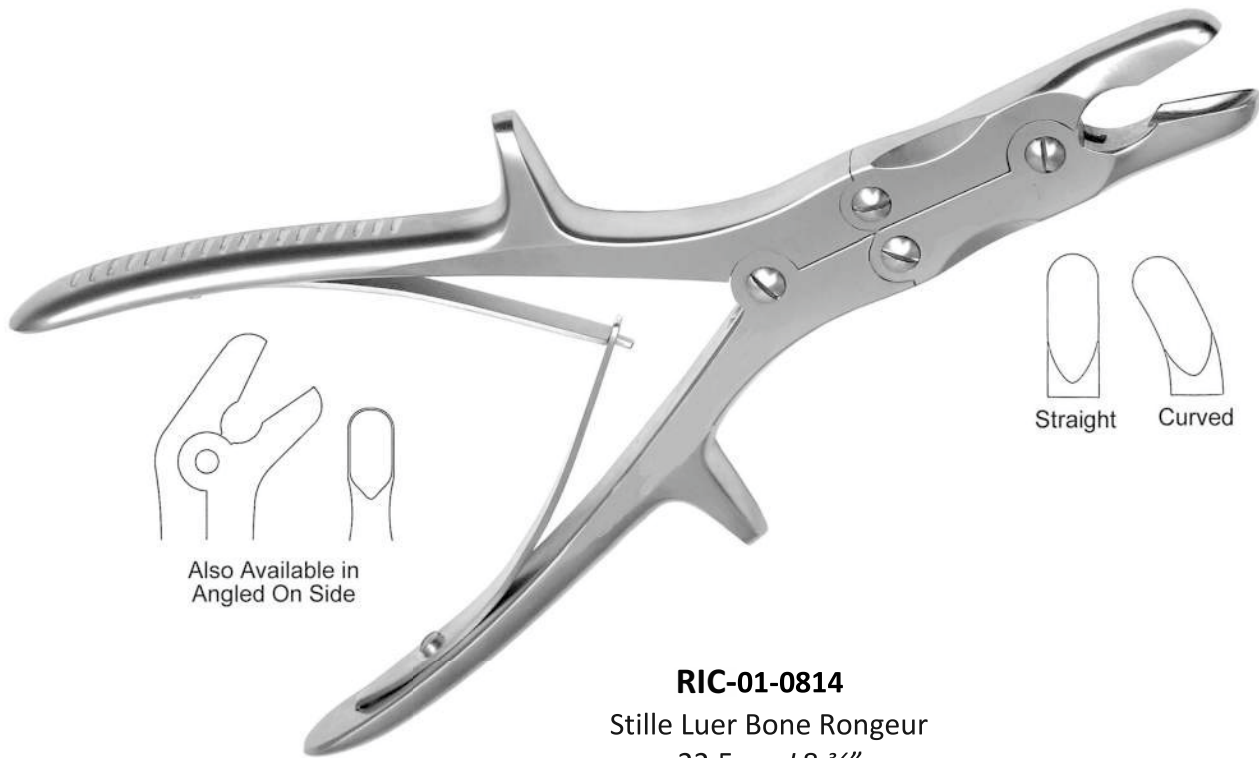

Also Available in
Angled On Side

RIC-01-0814

Stille Luer Bone Rongeur
22.5 cm / 8 3/4"



RIC-01-0815
Mainz Long Neck Bone Rongeur
18 cm / 7"



RIC-01-0816
Leksell Bayonet Rongeur
41 cm / 16"

A: 3mm
B: 5mm
C: 8mm

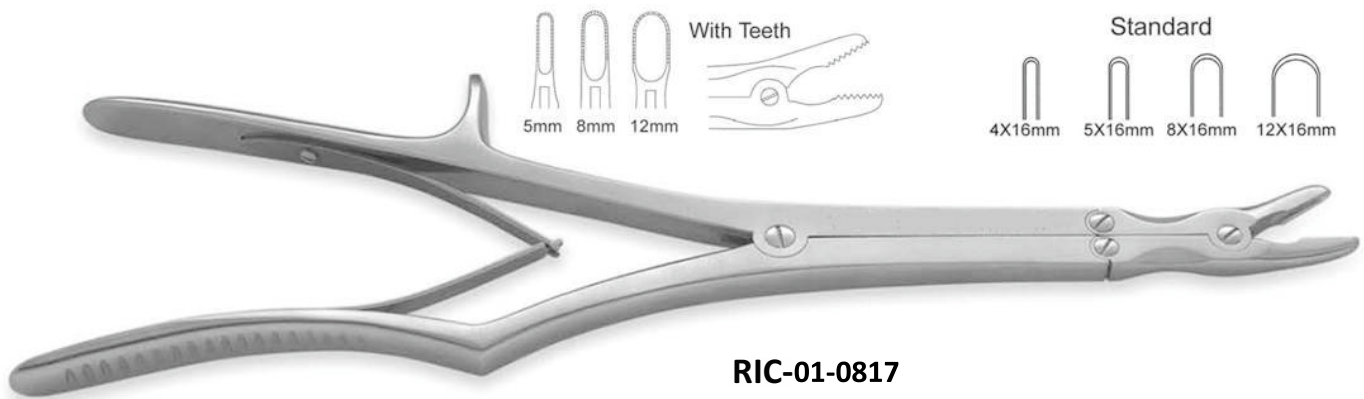

RIC-01-0817
Syfert Rongeur 37 cm / 14 ½"

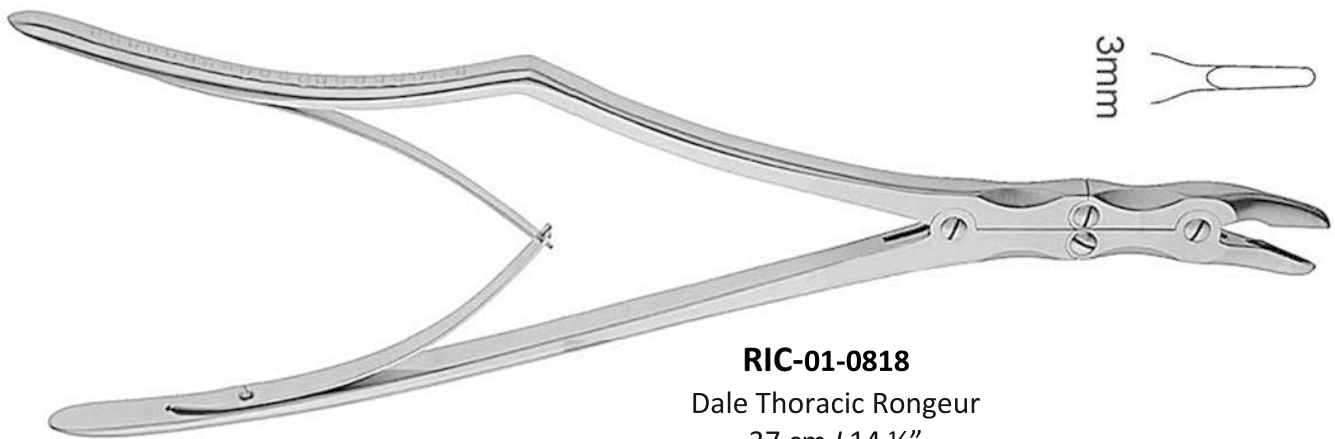

RIC-01-0818
Dale Thoracic Rongeur
37 cm / 14 ½"

LAMINA SPREADERS - RETRACTORS

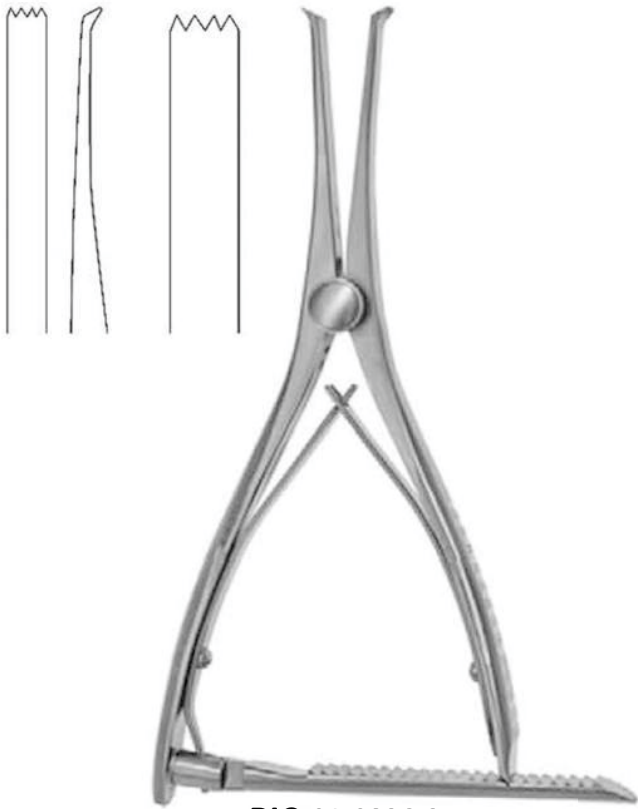

RIC-01-0836-2

Vertebra Spreader / Retractor
A: 18 cm / 7" | **B:** 28 cm / 11"



RIC-01-0837

Inge Spreader
 Serrated Outside Blades 18 cm / 7"



RIC-01-0838

Saxsena Lamina Spreader / Retractor
A: 18 cm / 7" | **B:** 25.5 cm / 10"
 Serrated Outside Blades

CALCANEAL - LAMBARDI SPREADERS



RIC-01-0839
 Calcaneal Spreader
 Smooth Pads 15X12mm
 18 cm / 7"



RIC-01-0840
 Calcaneal Spreader
 Grooved Pads 15X12mm
 18 cm / 7"



RIC-01-0841
 Lombardi Femoral Tibial Spreader (Small)
A: Grooved Pads 22X13mm 18 cm / 7"
B: Diamond Cut Pads 22x13mm / 7"



B: Diamond Cut Pads 22X13mm



B: Diamond Cut Pads 22X13mm



RIC-01-0842
 Lombardi Femoral Tibial Spreader (Large)
A: Grooved Pads 22X13mm 23.5 cm / 9 ¼"
B: Diamond Cut Pads 22x13mm / 9 ¼"

CARBIDE INSERTED SURGICAL SCISSORS

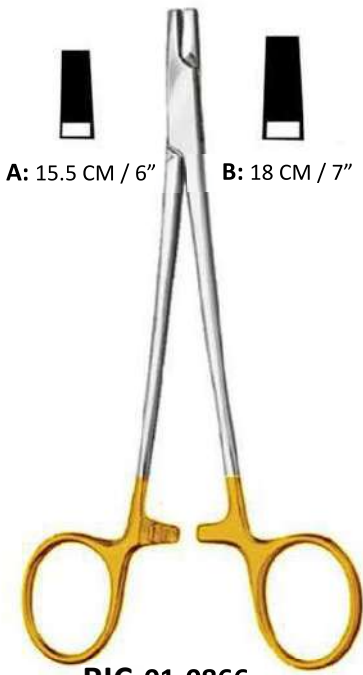

RIC-01-0866
Wire Twisting Forceps



RIC-01-0867
Wire Twisting Forceps

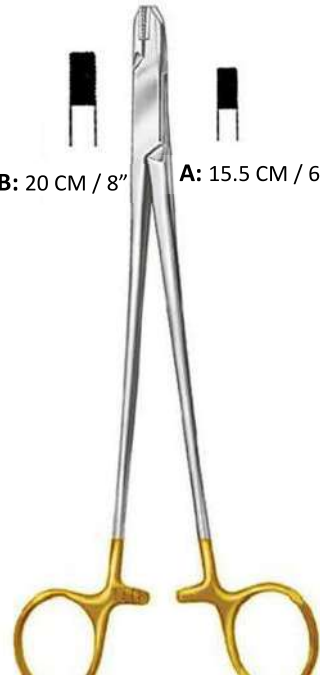

RIC-01-0868
Wire Twisting Forceps



RIC-01-0869
Corwin Combi-Wire Twisting Forceps 18.5 cm / 7 1/4"



RIC-01-0870
Wire Twisting Forceps
15.5 cm / 6"

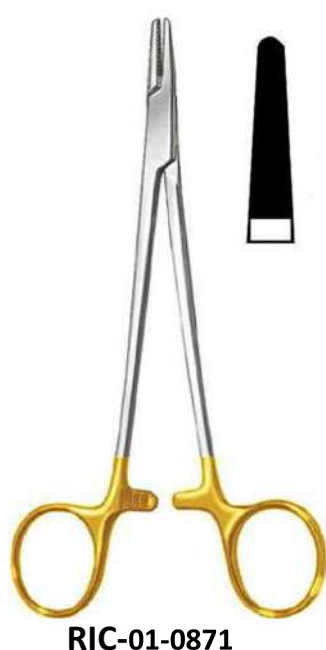

RIC-01-0871
Wire Twisting Forceps
16 cm / 6 1/4"



RIC-01-0872
Wire Twisting Forceps
Heavy Pattern
19 cm / 7 1/2"

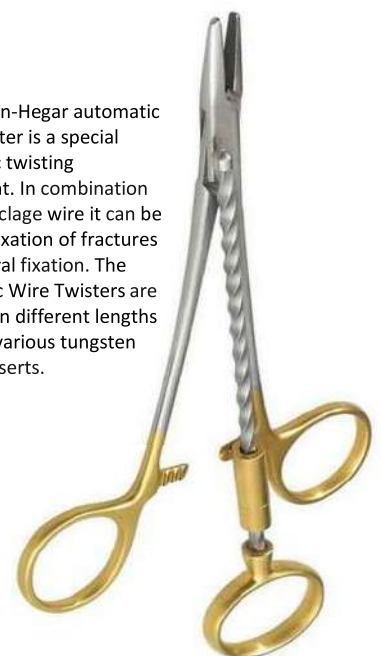

RIC-01-0873
Corwin-Hegar
Auto Wire Twisting Forceps
15 cm / 6"

The Corwin-Hegar automatic Wire Twister is a special automatic twisting Instrument. In combination with a cerclage wire it can be used for fixation of fractures or temporal fixation. The Automatic Wire Twisters are available in different lengths and with various tungsten carbide inserts.

CARBIDE INSERTED SURGICAL SCISSORS

Blunt / Blunt

- A: 14.5 cm / 5 ¾" Str or Cvd
- B: 17 cm / 6 ¾" Str or Cvd
- C: 23 cm / 9" Str or Cvd



RIC-01-0874

Mayo Scissors TC Gold

Sharp / Sharp
Cvd or Str

Blunt / Blunt
Cvd or Str

Sharp / Blunt
Cvd or Str

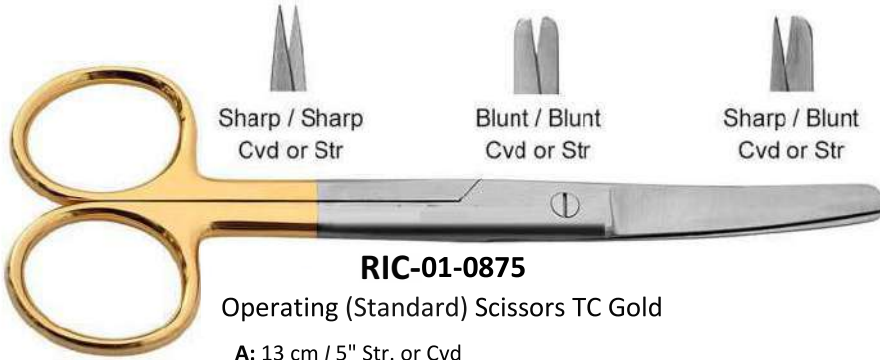

RIC-01-0875

Operating (Standard) Scissors TC Gold

- A: 13 cm / 5" Str. or Cvd
- B: 14 cm / 5 1/2" Str. or Cvd
- C: 15.5 cm / 6 1/2" Str. or Cvd
- D: 18 cm / 7" Str. or Cvd

Blunt / Blunt

- A: 14.5 cm / 5 ¾" Str. or Cvd.
- B: 17 cm / 6 ¾" Str. or Cvd.
- C: 23 cm / 9" Str. or Cvd.

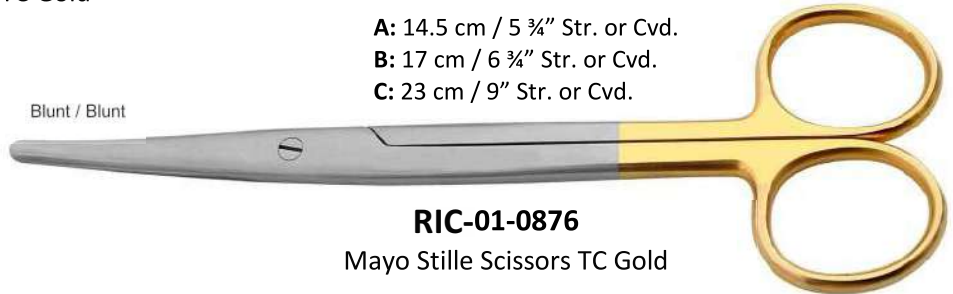

RIC-01-0876

Mayo Stille Scissors TC Gold

- A: 14 cm / 5 ½" Str. or Cvd
- B: 17 cm / 6 ¾" Str. or Cvd
- C: 20 cm / 8" Str. or Cvd
- D: 23 cm / 9" Str. or Cvd

Blunt / Blunt



RIC-01-0877

Metzenbaum Scissors TC Gold

Blunt / Blunt

- A: 20 cm / 8" Str. or Cvd
- B: 23 cm / 9" Str. or Cvd
- C: 28 cm / 11" Str. or Cvd
- D: 30 cm / 12" Str. or Cvd



RIC-01-0878

Mayo-Harrington Scissors TC Gold

RIC-01-0879

Ortho Universal Scissors TC Gold
12 cm / 4 1/3"



RIC-01-0880

Mayo-Nobel Scissors TC Gold
16.5 cm / 6 ½" Str. or Cvd



INSTRUMENTS FOR TRUAMATOLOGY



Drill Bits for Quick Coupling

Drill bit 1.1mm dia.
for threaded hole for 1.5mm screws

Drill bit 1.5mm dia.

For threaded hole for 2.0mm screws and gliding hole for 1.5mm
Screws

Drill bit 2.0mm dia.

For threaded hole for 2.7mm dia.

For gliding hole for 2.7mm screws

<u>Item</u>	<u>Diameter</u>	<u>Total length</u>	<u>Usable length</u>
100.001	1.1mm	060mm	035mm
100.002	1.5mm	085mm	060mm
100.003	1.5mm	110mm	085mm
100.004	2.0mm	100mm	145mm
100.005	2.0mm	125mm	100mm
100.006	2.7mm	100mm	075mm
100.007	2.7mm	125mm	100mm
100.008	2.7mm	100mm	075mm
100.009	2.0mm	125mm	100mm

Drill bit 2.5mm dia.

For threaded hole for 3.5 and 4.0mm screws

Drill bit 3.5mm

for gliding hole for 3.5mm screws

<u>Item</u>	<u>Diameter</u>	<u>Total length</u>	<u>Usable length</u>
100.010	2.5mm	110mm	085mm
100.011	2.5mm	180mm	155mm
100.012	3.5mm	100mm	085mm
100.013	3.5mm	195mm	170mm

Drill bit 3.2mm dia.

For threaded hole for 4.5 and 6.5mm screws

Drill bit 4.5mm dia.

For gliding hole for 4.5mm screws

<u>Item</u>	<u>Diameter</u>	<u>Total length</u>	<u>Usable length</u>
100.014	2.0mm	100mm	145mm
100.015	3.2mm	225mm	200mm
100.016	3.2mm	145mm	120mm
100.017	3.2mm	195mm	170mm
100.018	4.5mm	145mm	120mm
100.019	4.5mm	195mm	170mm

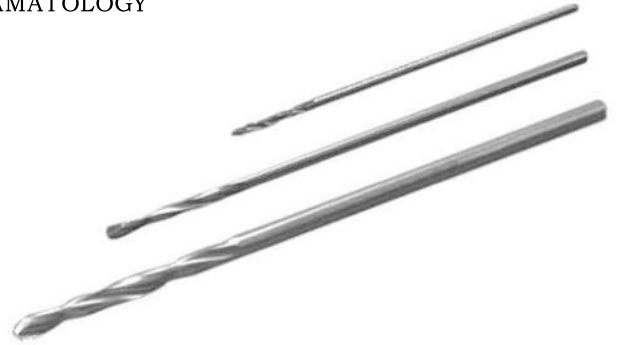

Drill Bit for Jacobs chuck

<u>Item</u>	<u>Diameter</u>	<u>Total length</u>	<u>Usable length</u>
101.001	1.1mm	45mm	30mm
101.002	1.5mm	70mm	55mm
101.003	2.0mm	85mm	70mm
101.004	2.5mm	95mm	80mm
101.005	2.7mm	85mm	70mm
101.006	3.2mm	130mm	115mm
101.007	3.2mm	180mm	165mm
101.008	3.5mm	95mm	80mm
101.009	3.5mm	180mm	165mm
101.010	4.5mm	130mm	115mm
101.011	4.5mm	180mm	165mm



RIC-01-0881

Tap for 1.5mm Cortex Screws

Total length 50mm, thread length 20mm
predrilling 1.1mm dia.



RIC-01-0882

Tap for 6.5mm Cancellous Bone Screws

Length 195mm, predrilling 3.2mm dia.



RIC-01-0883

Tap for 4.0mm Cancellous Bone Screws

Total Length 110mm, Usable Length 85mm



RIC-01-0884

Tap Cannulated, for 7.0mm Cannulated Screws
Length 230mm

INSTRUMENTS FOR TRUAMATOLOGY



Tap for 2.0mm Cortex Screws
Predrilling: 1.5mm dia.

Tap for 2.7mm Cortex Screws
Predrilling: 2.0mm dia.

Item	Thread	length
102.001	24mm	053mm
102.002	38mm	100mm

Item	Thread length	Total length
102.005	33mm	100mm
102.006	40mm	150mm

Tap for 3.5mm Cortex Screws
Predrilling: 2.5mm dia.

Item	Total length	Type
102.007	175mm	with length markings
102.008	110mm	thread length 50mm

Predrilling: 3.2mm

Item	Length	Type
102.003	125mm	thread length 70mm
102.004	175mm	with length markings

102.009

Tap for 3.5mm Cortex Screws

Total Length: 110mm

Thread Length: 50mm

Predrilling: 3.2mm dia.

102.010

Tap for 2.7mm Cortex Screws

Total length: 125mm

Thread length: 40mm

Predrilling: 2.0mm dia.

102.011

Tap for 4.5mm Cortex Screws

Total length: 125mm

Thread length: 70mm

Predrilling: 3.2mm dia.



RIC-01-0885

Countersink Shaft 1.5/2.0

Length 52mm, for mini quick coupling



RIC-01-0886

Router, for Jacobs chuck

Length 90mm



RIC-01-0887

Router, for quick coupling

Length 90mm



RIC-01-0888

Countersink Shaft 3.5mm

Length 72mm, for quick coupling,
to countersink the screw head

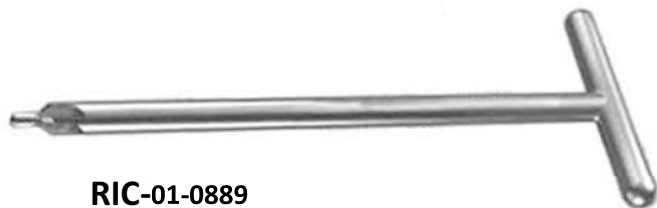

RIC-01-0889

Countersink, large

Length 180mm, for 4.5mm cortex screws



RIC-01-0890

Countersink, cannulated, for 7.0mm cannulated Screws

Length 230mm

INSTRUMENTS FOR TRUAMATOLOGY



RIC-01-0891

Screwdriver Shaft, hexagonal, small
Length 100mm, for quick coupling
For 2.7 to 4.0mm screws.



RIC-01-0892

Screwdriver Shaft, Hexagonal, large
Length 100mm, final tightening of the screw has to be done by hand.



RIC-01-0893

Screwdriver Shaft, hexagonal, with Holding Sleeve
For 1.5 and 2.0mm stainless steel screws
With hexagonal socket,



RIC-01-0894

Screwdriver Shaft, cruciform, 1.5/ 2.0, with Holding Sleeve
Length 50mm, for 1.5 and 2.0mm



RIC-01-0895

T-Handle with Coupling
Length: 80mm, for taps



RIC-01-0896

Screwdriver, hexagonal, with T-Handle,
Large to loosen tight screws.
A normal screwdriver can be additionally inserted in the hollow shaft of the T-handle.



RIC-01-0897

Handle with mini quick coupling



RIC-01-0898

Hand Chuck for Kirschner Wires
Length 145mm, Spannbereich 0.6 to 1.6mm dia.



RIC-01-0899

Handle with quick coupling
Length 110mm, for countersinks and
Instruments for the removal of damaged screws



RIC-01-0900

Handle, small, with mini quick coupling

INSTRUMENTS FOR TRUAMATOLOGY



RIC-01-0901
Handle, medium, with mini quick coupling



RIC-01-0902
Handle, Large, with mini quick coupling



RIC-01-0903
Screwdriver, hexagonal, small with groove
Length 200mm, for 2.7 to 4.0mm screws



RIC-01-0904
Screwdriver with Universal Joint, large
Length 290mm



RIC-01-0905
Screwdriver, hexagonal, large, with groove
Length 240mm



RIC-01-0906
Screwdriver, hexagonal, with Holding Sleeve,
Length 165mm for 1.5 and 2.0mm stainless
Steel screws with hexagonal socket



RIC-01-0907
Screwdriver, hexagonal, small, with Holding Sleeve
Length 200mm



RIC-01-0908
Holding Sleeve for Mini Screws single



RIC-01-0909
Holding Sleeve



RIC-01-0910
Holding Sleeve single



RIC-01-0911
Allen Key, hexagonal, angled
For 4.5 to 7.0mm screws

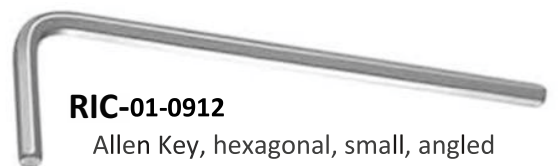

RIC-01-0912
Allen Key, hexagonal, small, angled
Length 65mm, for 2.7 to 4.0mm screws



RIC-01-0913
Insert Drill Sleeve 3.5/2.5
Length 42mm, drill bit 2.5mm dia.



RIC-01-0915
Trocar 2.0mm dia., Length 118mm, for percutaneous insertion of 7.0mm cannulated screws



RIC-01-0916
Drill Sleeve 4.5/ 2.0
Length 109mm, for percutaneous insertion of 7.0mm cannulated screws



RIC-01-0918
Handle for Drill Guides single

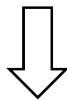

RIC-01-0919
Drill Sleeve 3.0 with point length 55mm



RIC-01-0923
Double Drill Sleeve 1.5/101
For 1.5mm cortex screws
Drill bits, 1.5 and 1.1mm dia.



RIC-01-0925
Double Drill Sleeve 2.7/2.0
For 2.7mm cortex screws



RIC-01-0914
Insert Drill Sleeve 4.5/3.2
Length 80mm for long lag screws



RIC-01-0917
Drill Sleeve 8.0/4.5
Length 100mm, for percutaneous insertion of 7.0mm cannulated screws



RIC-01-0920
Handle for Drill Guides single



RIC-01-0921
Drill Sleeve 1.5mm / 2.0 / 2.7mm

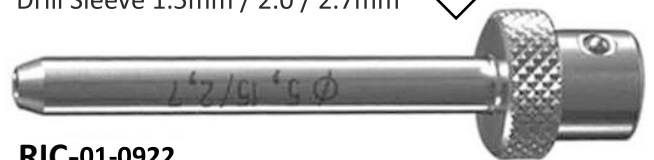

RIC-01-0922
Drill Sleeve 2.7



RIC-01-0924
Double Drill Sleeve 2.0/1.5 for
2.7mm cortex screw



RIC-01-0926
Double Drill Sleeve 3.5/2.5
For 3.5mm cortex screws and 4.0mm cancellous bone screws
Drill bits 3.5 and 2.5 dia.,

INSTRUMENTS FOR TRUAMATOLOGY



RIC-01-0927

Double Drill Sleeve 4.5/3.2
For 4.5mm cortex screws
Drill bits: 4.5 and 3.2mm dia.

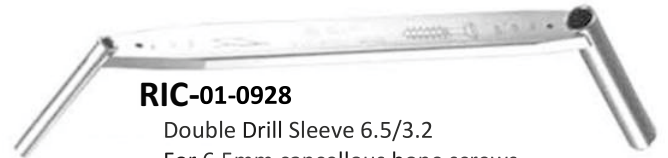

RIC-01-0928

Double Drill Sleeve 6.5/3.2
For 6.5mm cancellous bone screws
Drill bit: 3.2mm dia.



RIC-01-0929

Universal Drill Sleeve 2.7
Drill bits 2.0 and 2.7mm dia.,
Suitable for LC-DCP and round hole plates.



RIC-01-0930

Universal Drill Guide 3.5
Drill bit 2.5 and 3.5mm dia., and tissue protection
Suitable for LC-DCP and round hole plates.



RIC-01-0931

Universal Drill Guide 4.5/3.2
Drill bits 3.2 and 4.5mm dia.



RIC-01-0932

DCP Drill Guide 2.0
For neutral and load position
Drill bit 1.5mm dia.



RIC-01-0933

DCP Drill Guide 2.7
For neutral and load position
Drill bit 2.0mm dia.



RIC-01-0934

DCP Drill Guide 3.5
For neutral a load position, drill bit 2.5mm dia.



RIC-01-0935

DCP Drill Guide 4.5
For neutral and load position, drill bit 3.2mm dia.



RIC-01-0936

LC-DCP Drill Guide 3.5
For neutral a load position, drill bit 2.5mm dia.



RIC-01-0937

LC-DCP Drill Guide 4.5
For neutral and load position, drill bit 3.2mm dia.



RIC-01-0938

DCP Hip Drill Guide 4.5, for neutral and load position, for 4.5mm screws with DHS and angled blade plates, sleeve length 60mm, drill bit 3.2mm dia.

INSTRUMENTS FOR TRUAMATOLOGY



RIC-01-0939
Triple Drill Sleeve 2.0
with 3 holes, opposite side 1 hole



RIC-01-0940
DCP Mandible Drill Guide 2.7 short
drill bit 2.0mm dia.



RIC-01-0941
DCP Mandible Drill Guide 2.7 long
drill bit 2.0mm dia.



RIC-01-0942
Insert Drill Sleeve with stop, for 4.5mm screws
adjustable length to limit drilling depth,
external dia. 4.5mm for drill bits of 3.2mm dia.



RIC-01-0943
Parallel drill Guide 4.5
For percutaneous insertion of 7.0mm cannulated screws



RIC-01-0944
Parallel Wire Guide 2.0mm dia.



RIC-01-0945
Depth Gauge for 2.7 to 4.0m screws
measuring range up to 60mm



RIC-01-0948
Bending Iron for plates 2.7 and 3.5
Length 150mm, slid widths 2.5 and 4.5mm, required paris
Slid placement: 4.5 / 2.5
Slid placement: 2.5/4.5



RIC-01-0946
Depth Gauge for 2.7 to 4.0mm screws measuring
range up to 60mm



RIC-01-0947
Depth Gauge for 4.5mm to 6.5mm screws measuring
range up to 110mm



RIC-01-0949-1
Bending Iron for plates 1.5 and 2.5
Length: 130mm, slid width: 2.5mm

INSTRUMENTS FOR TRUAMATOLOGY



RIC-01-0958

Bending Iron for Kirschner Wires
Length 120mm, for 1.25 to 2.5mm dia.



RIC-01-0959

Bending Iron for Kirschner Wires
Length 115mm, for 0.8 to 1.25mm dia.



RIC-01-0960

Bending Iron for Reconstruction Plates 3.5 and 4.5
Length 190mm, required in paris



RIC-01-0961

Handle with Sleeve
with rotating drill guide and anchoring point



RIC-01-0962

Trocar Point, large



RIC-01-0964

Combination Wrench 11mm length 140mm



RIC-01-0963

Cheek Retractor Ring



RIC-01-0965

Pin Wrench, length 120mm, 4.5mm dia.
For tension device, distractor and knurled
nut of insertion handle for intramedullary nail

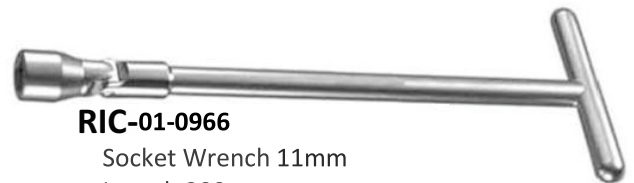

RIC-01-0966

Socket Wrench 11mm
Length 200mm



RIC-01-0967

Slotted Hammer
Length 270mm



RIC-01-0969

Measuring Device
For drill bits, screws, Kirschner wires,
and Steinmann pins



RIC-01-0968

Inserter/Extractor, with Adjustable Clamps, length 270mm, for the
insertion and extraction of angled plates for adults and hip plates for
adolescents and children as well as tibial plateau osteotomy plates.

INSTRUMENTS FOR TRUAMATOLOGY



RIC-01-0970

Inserter/Extractor
Length 175mm, for infant hip plate and mini hip plate.



RIC-01-0971

Bending Pliers for Reconstruction Plates 2.7 and 3.5
Length 240mm



RIC-01-0972

Bending Pliers for plate 2.4 to 4.0
Length 230mm



RIC-01-0973

Cutter for thin plates 1.5 to 2.7
Length 256mm



RIC-01-0974

Bending Pliers
For reconstruction plates 2.7,
Length 270mm, required in paris



RIC-01-0975

Cerclage Wire Tightener
Length 260mm
For twisting, for temporary fixation during reduction



RIC-01-0976

Bending Pliers for Plates

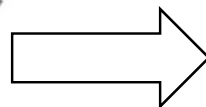

RIC-01-0977

Anvil, narrow



RIC-01-0978

Anvil, Large

INSTRUMENTS FOR TRUAMATOLOGY

RIC-01-0979
Bending Press
Length 400mm



RIC-01-0980
Tension Device, articulated
Span 20mm, can also be used as a distractor.
Color scale: yellow up to 500N, green up to 1000N,
red above 100N.

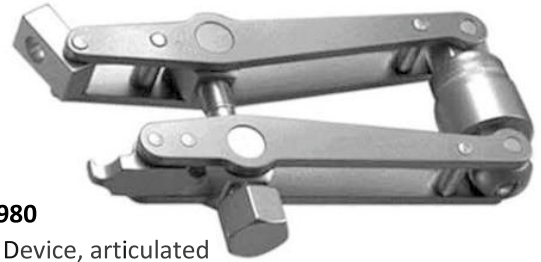

RIC-01-0981
Chisel Guide
With adjustable angle



RIC-11-01-0983
Blade with foot single

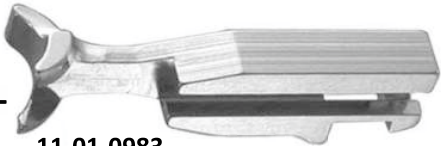

RIC-01-0984
Blade with tip single

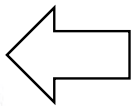
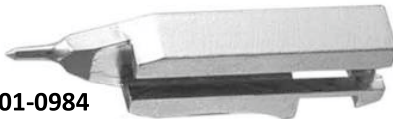

RIC-01-0982
Forceps with Sliding Blades
Complete with two interchangeable blades
Length 155mm, weight 42 g, speed lock

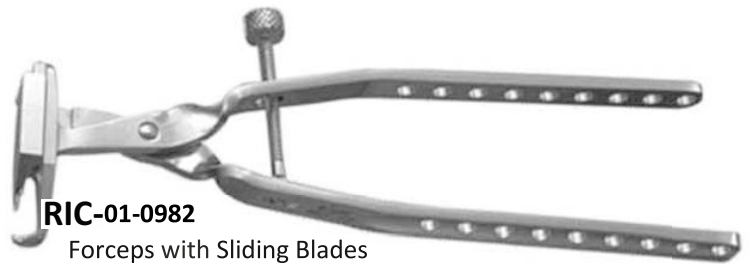

RIC-01-0985
Wire Passer 45mm bending diameter



RIC-01-0986
Wire Passer 70mm bending diameter



RIC-01-0987
Holding Clip



RIC-01-0988
Wire Tightener
Length 240mm, with handle and two pegs





RIC-01-0989
Handle with quick coupling
Length 150 mm



RIC-01-0990
Cancellous Bone Impactor, curved, 6mm dia.
Length 140 mm



RIC-01-0991
Cancellous Bone Impactor, curved, 6mm dia.
Flattened, Length 140 mm



RIC-01-0992
Cancellous Bone Impactor, straight, 8 mm dia.
Length 140 mm



RIC-01-0993
Cancellous Bone Impactor, rectangular,
6x16mm, Length 140 mm



RIC-01-0994
Cancellous Bone Impactor, rectangular,
10x20mm, Length 140mm



RIC-01-0995
Cancellous Bone Impactor, rectangular,
10x30mm, Length 140 mm



RIC-01-0996
Rasp round
Length: 140 mm



RIC-01-0997
Rasp, half-round
Length: 140 mm



RIC-01-0998
Gouge, straight, 5mm wide
Length 140 mm



RIC-01-0999
Gouge, curved, 5mm wide
Length 140 mm



RIC-01-1000
Gouge, straight, 10 mm wide
Length 140mm



RIC-01-1001
Gouge, curved, 10 mm wide
Length 140 mm



RIC-01-1002
Gouge, curved, 15 mm wide
Length 140 mm

INSTRUMENTS FOR TRUAMATOLOGY



RIC-01-1003

Gouge, straight, 15 mm wide
Length 140 mm



RIC-01-1004

Chisel, flat, curved, 16 mm wide
Length 140 mm



RIC-01-1005

Chisel, flat, straight, 16 mm wide
Length 140 mm



RIC-01-1006

Chisel, flat, curved, 4 mm wide
Length 140 mm



RIC-01-1007

Chisel, flat, 20 mm wide
Length 140 mm



RIC-01-1008

Chisel, flat, curved, 8 mm wide
Length 140 mm

PARALLEL PLIER WITH K WIRE CUTTER (T.C .TYPE)



**PARALLEL PLIER WITH K WIRE CUTTER (Soft wire 1.5mm)
223mm, 8" (T.C.Type) - RIC.PP.TC8
152mm, 6"(T.C.Type) – RIC.PP.TC6**



**PARALLEL PLIER WITH K-WIRE CUTTER 8 Inches
(1.5 mm Soft K.Wire to Cut) : RIC-PPK-IN8**



**PARALLEL PLIER WITH K WIRE CUTTER REGULAR 6 INCHES
(K WIRE CUTTER CUTS 1.5 mm Soft Wire)
RIC-RWC-PP6**

LATEST BONE LEVER



**Hohmann
ALDINGER
270 mm
RIC-01-8065**

**Schumacher
(Mod) Wagner
348 mm
RIC-01-8066**

**Schumacher
290 mm
RIC-01-8067**



RELIANCE INSTRUMENTS CORPORATION

CONTACT US



+91 44 4857 2311
+91 99625 67028 / 34 / 20



reico@relianceinstruments.com



217, SIDCO Industrial Estate, Ambattur, Chennai - 600 098